



# STREETS INVENTORY AND MANAGEMENT PLAN

March 2016



**SOLDOTNA**  
City of Soldotna, Alaska



**PDC INC. ENGINEERS**

170 E. Corral Ave., Suite 2  
Soldotna, AK 99669  
T: 907.420.0462



## **ACKNOWLEDGEMENTS**

### **City of Soldotna**

Lee Frey  
Kyle Kornelis, PE  
Scott Sundberg  
Stephanie Queen, AICP  
John Czarnezki  
Austin Johnson

### **PDC Inc. Engineers**

Patrick Cotter, AICP  
Matt Stone, PE  
Anne Nelson, PE  
Angela Smith, PE  
Bryan Hill

### **Shannon & Wilson, Inc.**

Kyle Brennan, PE

**ACKNOWLEDGEMENTS**

March 2016

**Soldotna Streets  
Inventory and Management Plan**

*[This page intentionally left blank.]*



## TABLE OF CONTENTS

<b>Acknowledgements</b> .....	<b>i</b>
<b>Table of Contents</b> .....	<b>iii</b>
<b>Abbreviations and Acronyms</b> .....	<b>v</b>
<b>Executive Summary</b> .....	<b>1</b>
Inventory .....	1
Maintenance.....	1
Capital Improvements .....	2
<b>1 Introduction</b> .....	<b>3</b>
1.1 Background of This Project.....	3
1.2 Why Have a Streets Management Plan? .....	4
1.3 How This Plan Fits with Other Plans.....	4
<b>2 Inventory of Existing Conditions</b> .....	<b>5</b>
2.1 Streets Inventory and Ratings .....	5
2.1.1 Public Outreach.....	5
2.1.2 PASER Methodology and Results .....	5
2.1.3 Street Ages .....	10
2.1.4 Functional Classifications .....	10
2.1.5 Existing Standards and Typical Sections.....	15
2.1.6 Performance .....	15
2.2 Maintenance Procedures Review .....	15
2.2.1 Winter Procedures .....	17
2.2.2 Summer Procedures.....	18
2.2.3 Staffing .....	19
<b>3 Guidelines</b> .....	<b>21</b>
3.1 Maintenance.....	21
3.2 When to Patch, Repave, or Reconstruct a Road .....	22
3.3 When to Pave a Gravel Road .....	28
3.3.1 Why Would You Want To Pave a Gravel Road? .....	28
3.3.2 What Are the Costs Associated with Maintaining a Gravel Road? .....	31
3.3.3 What Drives the Cost of an Upgrade from Gravel to Pavement? .....	32
3.3.4 Determining When to Pave a Gravel Road .....	33
3.4 Typical Sections .....	34
<b>4 Recommendations</b> .....	<b>37</b>
4.1 Prioritization Process .....	37
4.2 Maintenance.....	38
4.3 Capital Improvements .....	43
4.3.1 Funding .....	45
4.3.2 Projects Recommended for the Near Term .....	47
<b>5 References</b> .....	<b>51</b>

**List of Figures**

Figure EX1 - PASER Values by Percentage of Street Miles ..... 1  
Figure 1 – Total Miles of Streets by PASER Value ..... 6  
Figure 2 – PASER Ratings ..... 7  
Figure 3 – Left: Residential Street in an Older Subdivision / Right: Residential Street in a Newer Subdivision ... 9  
Figure 4 – Left: Gravel Road in Good Condition (Rating 8) / Right: Gravel Road in Poor Condition (Rating 4) .... 9  
Figure 5 – Street Ages ..... 11  
Figure 6 – Functional Classifications ..... 13  
Figure 7 – Per Capita Spending in Street Maintenance in Select Cities ..... 17  
Figure 8 – City Grader with Driveway Gate in Action ..... 18  
Figure 9 – Conceptual Timeline of Pavement Degradation ..... 27  
Figure 10 – Recommended Pavement Management Strategy ..... 27  
Figure 11 – Gravel Roads ..... 29  
Figure 12 – Preventive Maintenance versus Capital Improvements Based on Prioritization Formula ..... 39  
Figure 13 – Preventive Maintenance Priorities ..... 41  
Figure 14 – Capital Improvement Priorities ..... 45  
Figure 15 – South Kobuk Street ..... 47  
Figure 16 – Unpaved Segment of Lord Baranof Street ..... 48  
Figure 17 – N. Kobuk Street ..... 48  
Figure 18 – Brentwood Street ..... 49  
Figure 19 – Smith Way ..... 49  
Figure 20 – East Park Avenue ..... 50  
Figure 21 – Sharkathmi Avenue ..... 50

**List of Tables**

Table EX1 – Recommended Near-Term Capital Projects ..... 2  
Table 1 – Components of the Plan ..... 3  
Table 2 – PASER Values and Recommended Actions ..... 5  
Table 3 - Percentage of Streets at Specific PASER Values ..... 6  
Table 4 – Requirements from 1985 Standard Construction Specifications ..... 15  
Table 5 – Asphalt Distress Types and Likely Causes ..... 23  
Table 6 – PASER Scores by Functional Class ..... 24  
Table 7 – Rehabilitation Techniques for Specific Asphalt Pavement Distresses ..... 25  
Table 8 – Relative Rehabilitation Treatment Costs ..... 26  
Table 9 – Recent Gravel-to-Pavement Projects in Soldotna ..... 32  
Table 10 – Alternative Surfacing Materials Comparison ..... 33  
Table 11 – Existing vs. Proposed Section Comparison ..... 35  
Table 12 – Traffic Volume Factors by Functional Classification ..... 38  
Table 13 – General Guidelines for Maintaining New Asphalt ..... 38  
Table 14 – Near-Term Capital Improvement Projects ..... 44  
Table 15 – Long-Term Capital Improvement Projects ..... 44

**Appendix A – Public Comments**

**Appendix B – Typical Sections**

## ABBREVIATIONS AND ACRONYMS

ADA.....	Americans with Disabilities Act
ADT.....	Average Daily Traffic
CMAQ.....	Congestion Mitigation and Air Quality
DOT&PF.....	State of Alaska Department of Transportation & Public Facilities
FHWA.....	Federal Highway Administration
FMATS.....	Fairbanks Metropolitan Area Transportation System
HSIP.....	Highway Safety Improvement Program
PASER.....	Pavement Surface Evaluation and Rating
RAP.....	Recycled Asphalt Pavement
ROW.....	Right of Way
SAD.....	Special Assessment District
STBG.....	Surface Transportation Block Grant
TAP.....	Transportation Alternatives Program
USDA.....	United States Department of Agriculture

*[This page intentionally left blank.]*

## EXECUTIVE SUMMARY

This document does three things:

1. Establishes a baseline inventory of street conditions
2. Presents a series of guidelines for determining which repair or preservation strategies to implement
3. Provides recommendations for maintenance procedures and capital projects

## Inventory

The City of Soldotna maintains approximately 30 miles of paved streets and 11 miles of gravel roads. All 41 miles of streets were evaluated against the Pavement Surface Evaluation and Rating (PASER) system and assigned values between 1 (failed) and 10 (excellent). Approximately 72% of city streets received ratings of 6 or higher, indicating that most streets are in good condition.

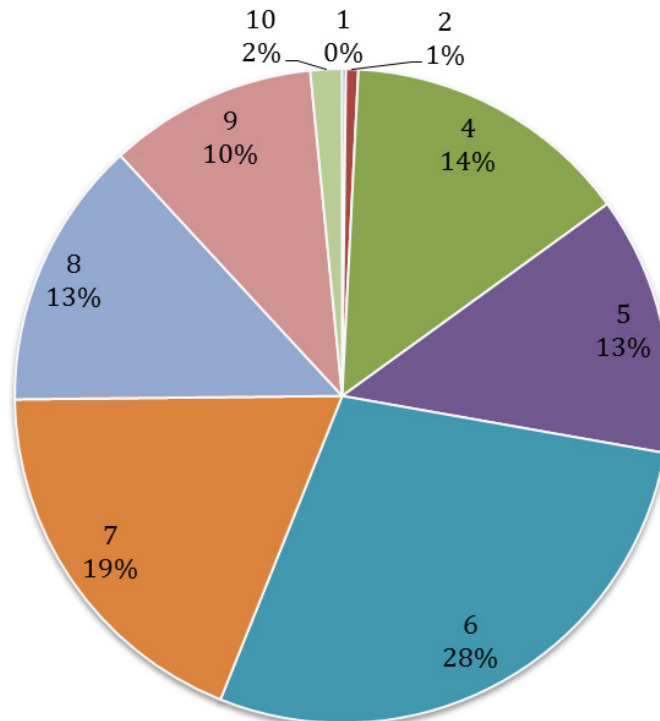

Figure EX1 – PASER Values by Percentage of Street Miles

## Maintenance

A comprehensive assessment of the city's maintenance program indicates that the City of Soldotna has done an excellent job maintaining city streets and provides a level of service comparable to or slightly better than cities of similar size and geography. On-going preventive maintenance should focus on higher volume streets, particularly those in better condition, to maintain the city's capital investments.

## Capital Improvements

Thanks to consistent maintenance practices, the city streets do not need extensive capital repairs. Based on an analysis of pavement conditions, pavement age, and street functional classification, capital improvements include road reconstruction and several gravel-to-pavement projects totaling approximately \$2,165,000 over the next five years.

**Table EX1 – Recommended Near-Term Capital Improvement Projects**

<b>Project</b>	<b>Year</b>	<b>Cost Estimate</b>	<b>Type</b>
<b>S. Kobuk Street Rehabilitation</b>	2017	\$415,000	Reconstruct/rehabilitate
<b>Lord Baranof Street Paving</b>	2017	\$390,000	Gravel-to-pavement
<b>N. Kobuk Street Rehabilitation</b>	2018	\$640,000	Reconstruct/rehabilitate
<b>Brentwood Street Rehabilitation</b>	2018	\$ 30,000	Reconstruct/rehabilitate
<b>Smith Way Rehabilitation</b>	2019	\$200,000	Reconstruct/rehabilitate
<b>E. Park Avenue Rehabilitation</b>	2019	\$ 80,000	Reconstruct/rehabilitate
<b>Sharkathmi Avenue Paving</b>	2020	\$410,000	Gravel-to-pavement

# 1 INTRODUCTION

The Soldotna Streets Inventory and Management Plan is a comprehensive assessment of the state of the City’s street network. It includes guidelines for design and maintenance of city streets, as well as prioritized recommendations for improvements. The plan was developed in three phases:

- Assess street conditions according to the Pavement Surface Evaluation and Rating (PASER) system
- Develop guidelines for maintenance, operations, and construction
- Develop recommendations and a capital improvement plan based on the results of the first two steps

The primary components of this plan are described in Table 1.

**Table 1 – Components of the Plan**

<b>Plan Component</b>	<b>Purpose(s)</b>
<b>Street Inventory</b>	Assess the current condition of City streets Develop a system and methodology for regular collection of street condition data
<b>Guidelines</b>	Define metrics for determining which repair or preservation strategies to implement and when to pave gravel roads
<b>Recommendations</b>	Develop a program of cost-effective projects that will be incorporated into the 5-year capital improvement plan Identify potential policy changes that would improve management of the street network

## 1.1 Background of This Project

The City of Soldotna hired PDC Inc. Engineers to conduct a streets inventory and develop a streets management plan. With over 40 miles of streets in the city, city officials wanted a document that provided a blueprint for prioritized street improvements.

The project’s primary focus was to rate the condition of the streets owned and maintained by the City and identify areas that need improvement. This information would then serve as the basis for a capital improvement plan. The document also serves as a justification tool that will allow consistency in policy decisions.

A previous study in 2001 evaluated traffic volumes and missing links in the city’s street network but did not evaluate maintenance procedures, document existing pavement conditions, or make recommendations for overall pavement management. Much of the historic maintenance activity is based on institutional knowledge. Capital projects have historically been selected through City Council and Administration review of each department’s priority projects. These priorities were weighed against available funding and programmed accordingly.

## 1.2 Why Have a Streets Management Plan?

Roadway infrastructure, particularly asphalt pavement, represents one of a municipality's largest investments. It is therefore worthwhile to develop and implement a program for systematically maintaining that investment.

A streets management plan allows a municipality such as the City of Soldotna to assess the condition of its roadways and make more efficient financial decisions about roadway improvements. The goal is to improve the overall roadway system by considering all of them in a systematic manner. Improvements to a particular roadway are analyzed by considering maintenance costs, riding surface, and the additional expense related to other roadways within the city. The following steps are typically included in a streets management plan.

- **Inventory the roadways:** Survey the mileage and condition of the roadways throughout the system.
- **Assess the condition of the roadways:** Use consistent survey techniques from year to year to analyze the pavement or gravel surface.
- **Select a roadway management strategy:** Use appropriate treatments to repair problem areas.
- **Determine present needs:** Estimate the cost of repair and establish long range goals and objectives.
- **Establish priorities:** Use preventive maintenance to keep roadways in proper shape and reconstruct roadways in very poor condition.

Using a streets management plan allows the city to spend their limited funds more wisely by determining the most cost-effective and long-term improvements and maintenance for the street network.

## 1.3 How This Plan Fits with Other Plans

The Soldotna Streets Inventory & Management Plan is complementary to other city plans such as Envision Soldotna 2030, Soldotna Safe Routes to School, the Downtown Improvement Plan, and the Recreation & Trails Master Plan. It represents one implementation tool of these plans by officially identifying the location, classification, and street section requirements needed to meet the long-range transportation goals of the City. All of these plans should be reviewed before implementing any of the recommendations to ensure that all improvements are accommodated.



## 2 INVENTORY OF EXISTING CONDITIONS

### 2.1 Streets Inventory and Ratings

The streets inventory consisted of two primary components:

- **Evaluate** the streets' condition
- **Classify** the streets' functionality

The condition and functional classification of the street network relate to all other components of this plan.

#### 2.1.1 Public Outreach

Public involvement was limited to stakeholder interviews, an open house, and a call for public comments via an online map embedded in the City's website.

Stakeholders included the Kenai Peninsula Borough School District, City of Soldotna Police Department, and Central Emergency Services. None of the stakeholders expressed concern about the condition of the street network. Comments focused on snow removal along local roads and traffic congestion along the Sterling Highway and Kenai Spur Highway, which are state-maintained highways.

Fourteen comments were received via the online web map and two were received at the open house. Comments addressed a number of concerns ranging from gravel road conditions to roundabout safety (see Appendix A).

#### 2.1.2 PASER Methodology and Results

The PASER methodology relies on visual inspection to evaluate four major categories of common asphalt pavement surface distress:

- **Surface Defects:** Raveling, flushing, polishing
- **Surface Deformation:** Rutting, distortion, settling, frost heave
- **Cracks:** Transverse, reflection, slippage, longitudinal, block, alligator
- **Patches and Potholes**

Under the PASER methodology, paved streets are given a rating from 10 (excellent) to 1 (failed) based upon a representative section of the street segment. The numeric ratings correspond to a series of recommendations for maintenance or repair.

**Table 2 – PASER Values and Recommended Actions**

Rating	Recommended Action
9-10	No maintenance required
8	Little or no maintenance
7	Routine maintenance, crack sealing, minor patching
5-6	Preservative treatments (seal-coating)
3-4	Structural improvement and leveling (overlay or recycling)
1-2	Reconstruction

The gravel roads within the city were evaluated and rated according to the Gravel PASER manual. The methodology is similar to the PASER system for asphalt, with visual inspections focusing on five aspects of a road segment’s condition:

- **Crown:** Height and condition
- **Drainage:** The ability of roadside ditches and culverts to carry water away from the road
- **Gravel Layer:** Adequate thickness and quality of gravel to carry traffic loads
- **Surface Deformation:** Washboarding, potholes, and ruts
- **Surface Defects:** Dust and loose aggregate

Under the gravel PASER methodology, gravel roads are given a rating from 5 (newly constructed road) to 1 (complete rebuilding required). For consistency with the asphalt PASER ratings, these gravel ratings were converted to the 1-10 scale shown above.

**2.1.2.1 PASER Results**

The condition of city streets runs the gamut from narrow, potholed gravel roads to brand new urban asphalt streets.

The city streets are generally in good condition. Approximately 44% of total street miles are rated 7 or higher, which means they only require routine maintenance. Another 41% of the streets are rated 5 or 6 and require preservative treatments. Only 15% of total city street miles require major improvements. See Figure 2 and Table 3 for a complete breakdown of the PASER values.

**Table 3 - Percentage of Streets at Specific PASER Values**

Rating	Percent of Streets
9-10	12%
8	13%
7	19%
5-6	41%
3-4	14%
1-2	1%

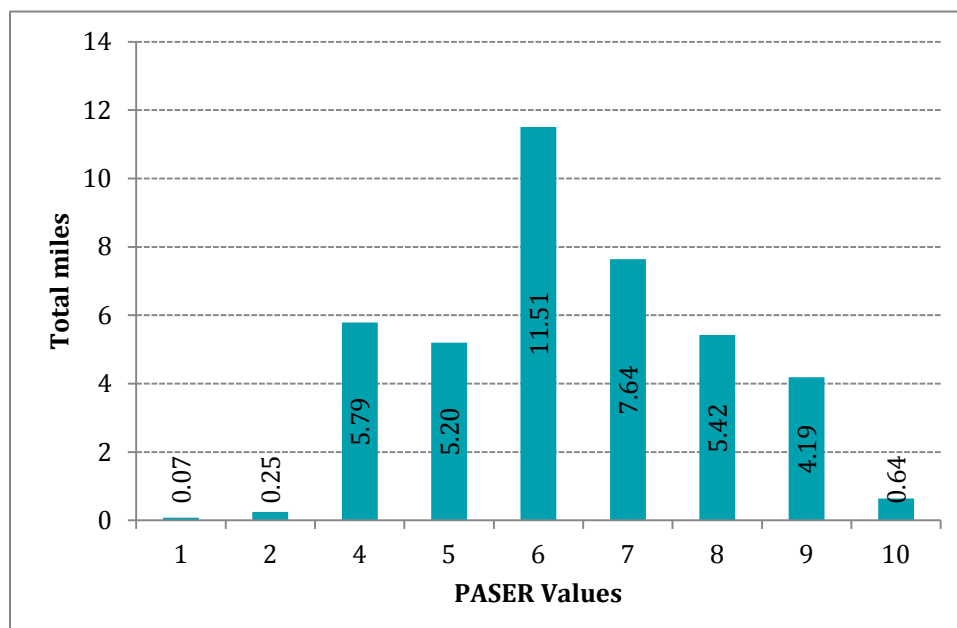

**Figure 1 – Total Miles of Streets by PASER Value**

**PASER Values**

- 10 - Excellent
- 9 - Excellent
- 8 - Very Good
- 7 - Good
- 6 - Good
- 5 - Fair
- 4 - Fair
- 2 - Very Poor
- 1 - Failed

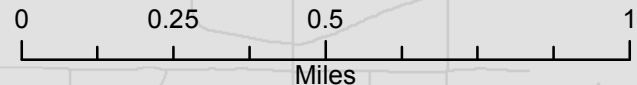
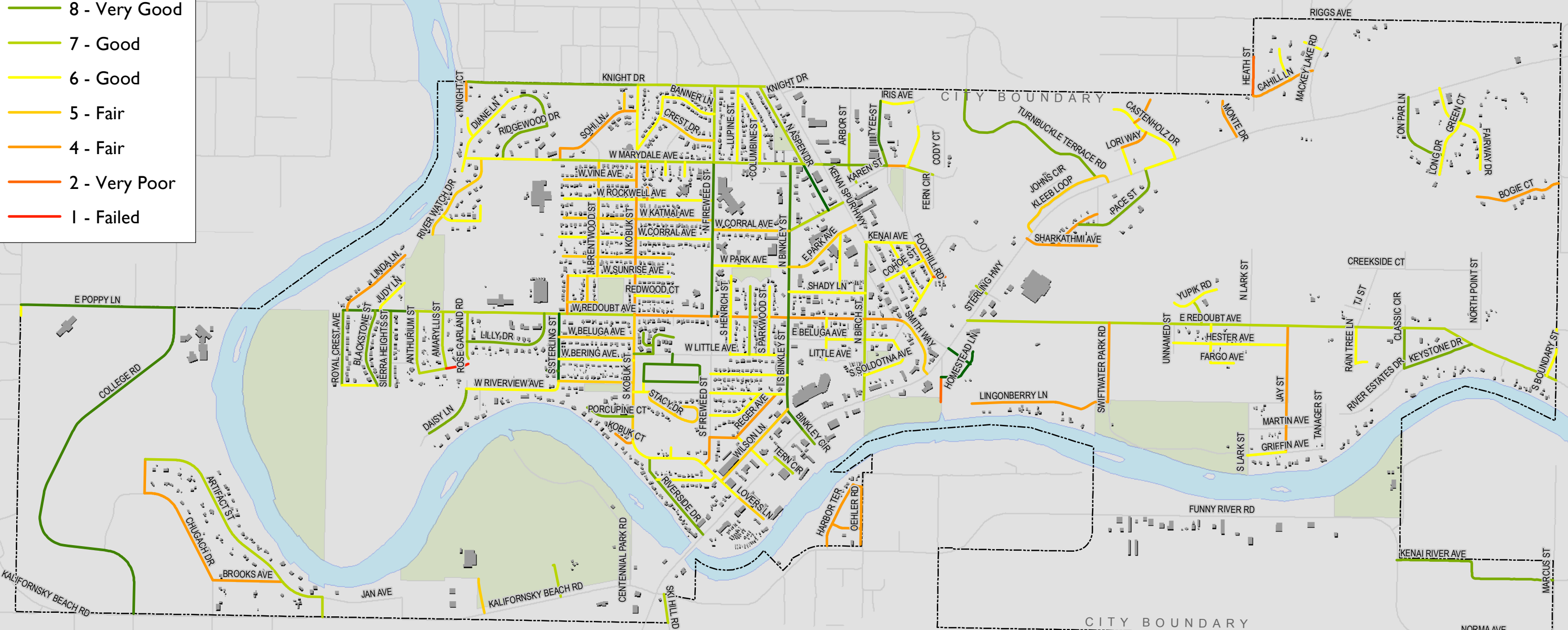

FIGURE MAR 2016 SOLDOTNA STREETS INVENTORY AND MANAGEMENT PLAN

PROJ. No. **15050FB**

**PASER RATINGS**



*[This page intentionally left blank.]*



Many of the residential streets in the city's core were rated at 6 or lower. This is likely due to the fact that many of these roads were constructed or reconstructed around the same time and see similar traffic types and volumes. Newer subdivisions generally have roads in better condition, with ratings of 8 or higher. Figure 3 shows the difference between two residential streets. In the photograph on the left (rated 6), although all cracks are sealed, there are transverse cracks, often at intervals of less than 10 feet, and also some early block cracking. The photo at right shows a street with a rating of 8; the only cracks present here are transverse cracks at intervals greater than 10 feet.



Figure 3 – Left: Residential Street in an Older Subdivision / Right: Residential Street in a Newer Subdivision

The condition of the gravel roads varied widely, as Figure 4 shows. Minor differences in drainage, grading, and traffic can greatly influence the condition of a gravel road, which likely explains the large variability in PASER ratings.



Figure 4 – Left: Gravel Road in Good Condition (Rating 8) / Right: Gravel Road in Poor Condition (Rating 4)

### **2.1.3 Street Ages**

Street ages were determined by reviewing as-built documents and through discussions with city public works staff. Street ages presented in Figure 5 represent the last time a street was reconstructed or underwent major rehabilitation.

### **2.1.4 Functional Classifications**

Defining each street's functional classification is important as it affects all other components of a streets management plan. The following functional classification system was used for the City:

- **Major Arterial:** Major Arterials are usually four or more lanes, generally connect various parts of the region with one another within the city and with the "outside world". They serve as major access routes to regional destinations and typically carry an average of more than 20,000 vehicles per day. These are typically owned by the State of Alaska in the Soldotna area.
- **Minor Arterial:** Minor Arterials are typically two or three lanes. These streets provide the next level of urban connectivity below major arterials. In most cases their main role tends to be serving intra-city mobility. Minor Arterials carry between 7,500 and 20,000 vehicles per day.
- **Major Collector:** Major Collectors can be found in residential, commercial and industrial areas. They typically carry between 2,500 and 7,500 vehicles per day.
- **Neighborhood Collector:** Neighborhood Collectors are found only in residential neighborhoods and provide a high degree of access to individual properties in a neighborhood. They typically carry between 1,500 and 2,500 vehicles per day.
- **Local:** Local streets' primary function is to provide access to individual property along the roadway. They are narrow, slow-speed, and low-volume service facilities. They typically carry fewer than 1,500 vehicles per day.

Streets were classified based on their primary use, estimated average daily traffic, and surrounding land uses. Within the city of Soldotna, the State of Alaska maintains the Major Arterials, which include K-Beach Road, the Sterling Highway, and Kenai Spur Highway. The remaining streets are predominantly local, with neighborhood and major collectors providing intra-city connections.

Traffic data were not available for all of the city's streets. State of Alaska Department of Transportation & Public Facilities (DOT&PF) traffic maps and surrounding land uses provided a basis for determining order-of-magnitude traffic volumes for most city streets.



# Age of Pavement

## Decade Built or Major Rehab

- 1970 - 1979
- 1980 - 1989
- 1990 - 1999
- 2000 - 2009
- After 2010

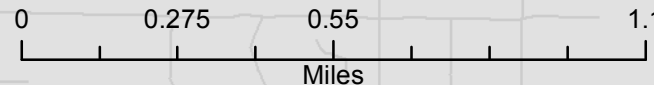
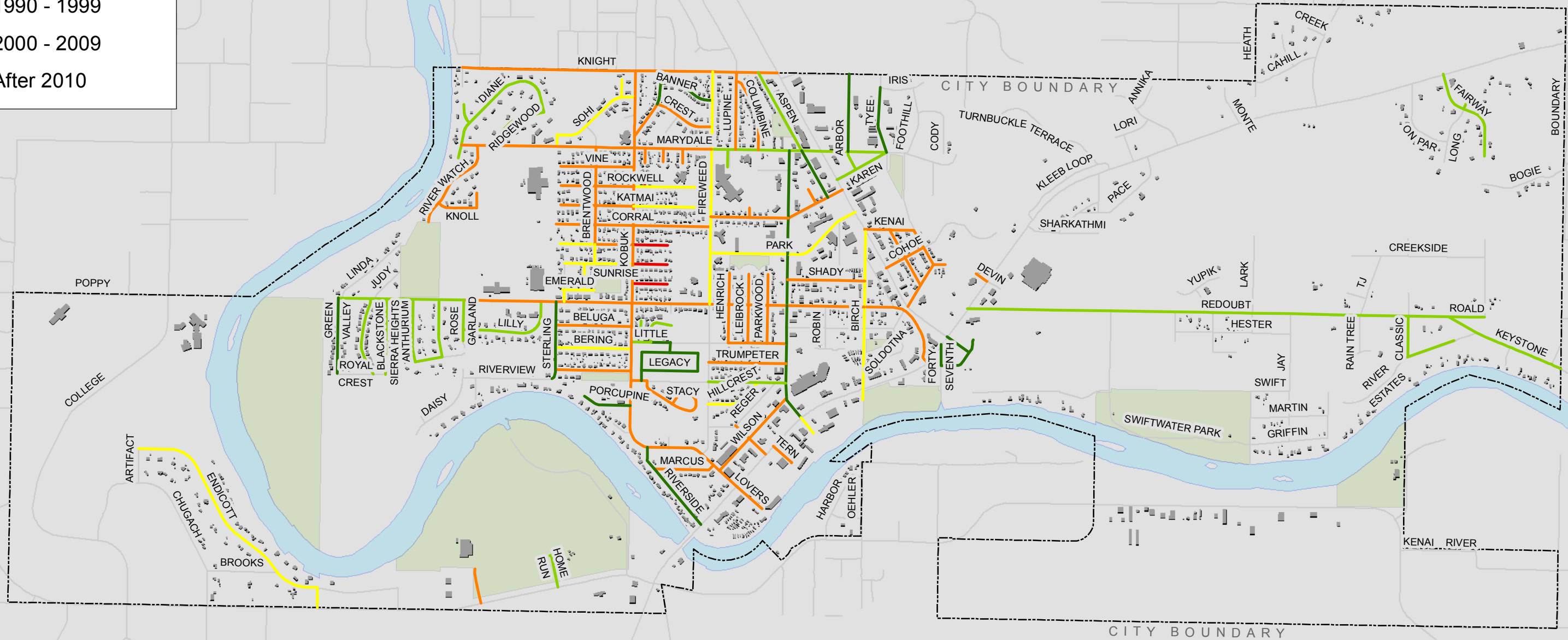

*[This page intentionally left blank.]*





*[This page intentionally left blank.]*

### 2.1.5 Existing Standards and Typical Sections

Within Soldotna city limits, the design roadway typical sections are based on the City of Soldotna’s 1985 Standard Construction Specifications (see Appendix B). For the areas outside the city limits, construction standards are included in the Kenai Peninsula Borough Code of Ordinances, Chapter 14.06, “Road Standards.”

Soldotna’s existing typical section standards are limited to residential, alley ways, and collector streets.

**Table 4 – Requirements from 1985 Standard Construction Specifications**

<b>Element</b>	<b>Dimensions</b>
<b>Right of Way</b>	60 feet wide
<b>Residential Street</b>	
<i>Minimum</i>	Two 12-foot-wide paved travel lanes Two 6-foot-wide gravel shoulders
<i>Fully Developed</i>	Two 12-foot-wide paved travel lanes Curb and gutter At least one 4-foot-wide sidewalk
<b>Collector Street</b>	
<i>Minimum</i>	Two 12-foot-wide paved travel lanes Two 6-foot-wide gravel shoulders
<i>Fully Developed</i>	Two 12-foot-wide paved travel lanes One 11-foot-wide paved center lane Two 3-foot-wide bike lanes Two 4-foot-wide sidewalks
<b>Structural Section</b>	2 inches of asphalt 2 inches of base course 6 inches of Type B classified fill 26 inches of Type A classified fill

### 2.1.6 Performance

Overall, the existing structural sections are performing well. With the exception of some isolated areas, most roadway damage and deterioration identified during the PASER study is due to pavement age, not due to subgrade failure. The isolated areas of subgrade failure could be attributed to the “bury pits” left during the original construction of the roads. The original ROW clearing and road construction was performed by scraping the organic overburden to one side of the ROW, mining gravels out of the road bed, and filling the gravel excavation with the organic material prior to constructing the roadway.

## 2.2 Maintenance Procedures Review

Review of the Soldotna maintenance department’s staffing and budget reveals a well-managed department with an experienced, stable work force utilizing resources appropriately in comparison to other communities of similar size.

The standards of maintenance that the City follows exceed normal maintenance standards both in the timing of snow removal and the extent of summer maintenance. For example, most initial snow removal plans simply push the snow off the roadway and accomplish cleanup over several days following a snow event. Soldotna strives to clean streets and sidewalks immediately and haul snow to dump areas the same day. Summer maintenance includes a program of improvements to drainage and road surfaces beyond simply maintaining what is in place. This philosophy results in consistent improvements, primarily on gravel roads that might otherwise require a contracted repair project in future years. The level of attention to quick and complete snow removal appears to be well received by the public which attracts business and home ownership within the City but also drives a higher than average per-mile cost.

A direct comparison of different cities' budgets or cost by mile of maintenance activities is not as straight-forward as one might think, and the following considerations should be kept in mind when making comparisons:

- As with other small cities, Soldotna's Maintenance Department does much more than just maintain streets. They are a multi-talented group of workers that assist the City in many areas, including water and sewer repairs, parks and recreation projects, and community events.
- The Maintenance Department doesn't maintain detailed records of individual tasks or specific street-by-street activities. To do so would require more operator time and resources devoted to recordkeeping, taking time away from higher-priority work. (However, the City is moving toward use of PubWorks® to further define task allocation and clarify cost centers. In future years, this information will provide more clarity on where budget is spent.)
- There is a reasonably accurate corporate knowledge of task allocation. For the purpose of this study, 20% of the overall streets budget is dedicated to tasks not directly attributable to street maintenance. This includes airport maintenance, assisting other departments, and indirect street maintenance such as signage and lighting.
- The current snow removal plan exceeds the standards of comparable cities both in Alaska and selected cities in the Lower 48 states. The primary differences lie in the aggressive cleaning of sidewalks and the immediate cleanup and hauling of snow. In many communities, these tasks are done during a clean-up phase that extends through several days after a snow event.
- In non-scientific outreach to various residents, the general response was that current snow removal, especially the clearing of pedestrian sidewalks and pathways, is viewed as a benefit of living in Soldotna. There is definitely a budgetary cost associated with an aggressive snow removal plan; however, there also appears to be an undefined desirable quality of life benefit.
- Although some snow events result in snow berms remaining in the street centers overnight or longer, the City's current policy is to make every effort to ensure this does not happen, as it is considered a potential safety concern. Tracking the number of snow events that result in berms being left in the traveled way overnight or longer will help determine if additional staffing or overtime might increase vehicle safety.

Figure 7 below shows the approximate per capita street maintenance spending of several Alaska cities. Even though this is a very rough approximation, it does show that the City of Soldotna’s maintenance spending per capita is in line with other comparably sized northern cities.

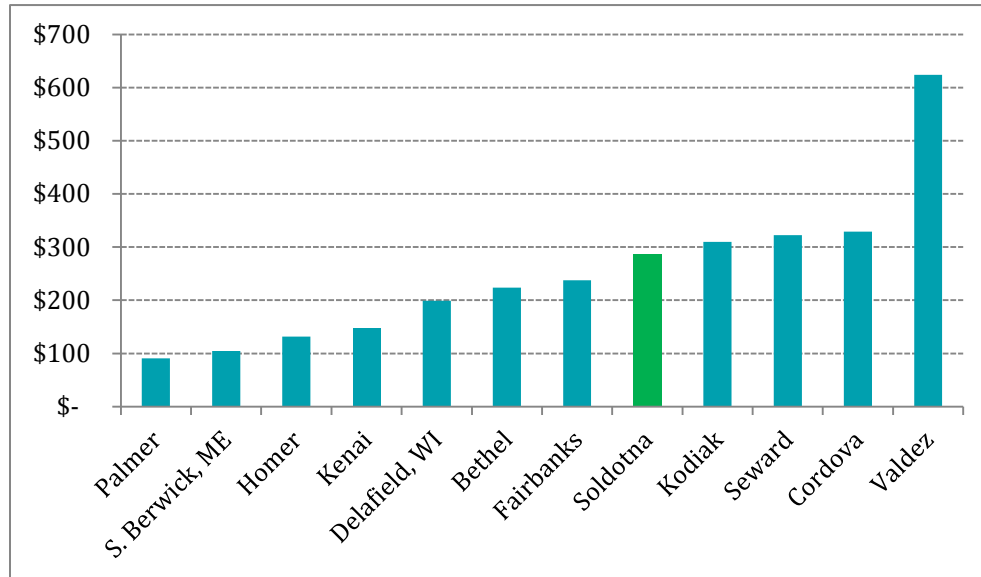

Figure 7 – Per Capita Spending in Street Maintenance in Select Cities

### 2.2.1 Winter Procedures

Soldotna is the most densely settled mid-sized (population 2,500 to 5,500) city in Alaska (*Envision Soldotna 2030*), which factors into the methodology used to clear snow. The Maintenance Department has developed a snow clearing plan that focuses on removing snow from sidewalks in conjunction with opening streets. Main arterial roads are the highest priority, followed by residential neighborhoods and then airport surfaces. On streets with sidewalks or a dense concentration of driveways, the snow is pulled to a berm in the center of the street and then blown into trucks and hauled to snow dump sites. Contracted dump trucks are on call to assist the City with snow hauling when justified by the amount of snowfall. The goal of the snow removal crew is to have all berms removed from City streets before the crew goes off shift. Staffing levels are insufficient to run more than one shift, although overtime is available if necessary to provide safe passage for emergency vehicles, passenger and commercial vehicles, and pedestrians.

Main highways and some access roads within the city limits are the responsibility of the State of Alaska. The City enjoys a productive, collaborative relationship with the local DOT&PF maintenance crews and routinely assists in clearing sidewalks on DOT&PF routes to ensure pedestrian safety. With extreme pressure on State of Alaska budgets, it is highly unlikely that local DOT&PF will be able to increase staffing, and the City may need to provide even more assistance clearing sidewalks and paths if they wish to meet or exceed current standards.

Where practical, snow on rural roads is removed by road graders clearing snow to ditches.



The City's graders are equipped with driveway gates to limit snow berms in driveways throughout the city. Recent changes to City standards that allow wider driveways will challenge the ability of these driveway gates to eliminate berms across the full width of wider driveways. The City is already using the most effective driveway gates available. Therefore, residents and developers taking advantage of the wider driveway allowances should be informed that driveway gates are only able to carry snow for a limited duration, and depending on snow depth and temperature, the gate-equipped graders may only be able to open a portion of wider driveways.



Figure 8 – City Grader with Driveway Gate in Action

Sand mixed with urea and salt to improve traction is applied throughout the winter and may take priority in staffing and budget when warmer weather with freezing rain and daily freeze-thaw cycles cause icing.

### **2.2.2 Summer Procedures**

The Maintenance Department utilizes existing staff and equipment to conduct maintenance during the summer months. When funds are available, temporary help is employed to facilitate crack sealing.

Primary maintenance activities on paved surfaces are patching, crack sealing, and drainage repair/improvements. Recent studies in Alaska and several other northern states have indicated that **crack sealing on newer paved surfaces (PASER score of 6 or higher) has the greatest effect on pavement life.** The challenge to the street maintenance crew is to

balance using limited resources to improve the lifespan of newer pavement against the need to patch older, deteriorating pavement (PASER rating of 4 or lower) that is not scheduled for resurfacing or reconstruction.

Gravel roads comprise approximately 11 miles, or 26%, of Soldotna's roads—but consume an estimated 52% of the Maintenance Department's time and resources during the summer. Summer maintenance for gravel roads includes ditch maintenance, grading, addition of gravel top course, and application of calcium chloride.

The use of calcium chloride to control dust and retain fines on gravel surfaces is a cost-effective maintenance technique proven through long use in Canada and across Alaska. The City uses tested application rates and maintenance standards to improve the condition of gravel surfaces with good results. During dry weather, gravel surfaces treated with calcium chloride are relatively stable. Heavy rain or prolonged periods of rain rapidly deteriorate gravel surfaces, however, and re-grading is only practical after surfaces have partially dried, generally 24 to 48 hours after rain ceases. Gravel roads will continue to experience weather related periods of poor surface conditions.

There is no indication that the public is displeased with the current gravel maintenance routine. Most Alaska residents are familiar with the challenges of maintaining a smooth surface on gravel during heavy rain, and the consistent improvement facilitated by calcium, drainage improvements, and addition of gravel appears to be sufficient. It is recommended that the City continue to assess cost and usage and pave gravel roads as and when it makes sense within the overall budget and vision. See Section 3.3 below for a full discussion on determining when to pave a gravel road.

### **2.2.3 Staffing**

As stated earlier, the Soldotna Maintenance Department has a very stable, experienced, and well trained work force. In previous years, the State of Alaska Technology Transfer program provided grader operator training for State and municipal employees on a regular basis. As State funding has decreased, those programs have been cut, and it is unclear if they will ever return. The responsibility for training equipment operators in the latest techniques and equipment capabilities thus falls back to the City. The City should consider budgeting for periodic operator training and travel to equipment seminars to remain informed of new advances in equipment and continually improve workforce competency, which will improve efficiency and overall outcomes. A contingency budget item to use contractor snow hauling funds for training in years of minimal snowfall would provide for periodic training without a budget increase.

City budget documents show a minimal increase in M&O spending over the past 6 years. The increase is primarily attributable to mandated employee benefits, material costs, equipment rental, and use of contracted services and has been offset by reducing spending in materials and other budget lines.

*[This page intentionally left blank.]*



### 3 GUIDELINES

Concurrent with the streets inventory and assessment, a series of guidelines were developed. The guidelines are based on the local conditions, best practices, and research and serve as a basis for the recommendations in this report.

#### 3.1 Maintenance

If the City wishes to implement recommendations from recent planning documents, such as changing response times for snow removal around schools and increasing maintenance of sidewalks and walking paths, then a review of staffing levels and equipment should be considered. It is unlikely that additional tasks can be implemented without additional staff.

The Maintenance Department currently uses on-call winter operators to supplement full-time staff. Additional on-call personnel might be a cost-effective option.

The City may also wish to review the Fairbanks Metropolitan Area Transportation System (FMATS) Seasonal Mobility Task Force Report (<http://fmats.us/seasonal-mobility-task-force/>), in which a number of stakeholders gathered information and resources to coordinate and explore new ways to improve pedestrian and non-motorized vehicle route snow removal. A similar effort to coordinate government resources with local business and non-profit entities might be beneficial in Soldotna.

The City of Soldotna should consider both economic and non-economic factors when considering changes in street maintenance priorities and staffing. One of the recurring themes in recent plans and studies is captured in the *Envision Soldotna 2030* comprehensive plan's stated vision for Highways and Transportation: "The City's motorized and pedestrian transportation network will be safe, efficient, and well-maintained year-round."

Assessment of potential changes should include the following considerations:

- Quality of life
- Local economy
- Traffic and pedestrian safety
- Access
- Sustainability of maintenance standards
- Worker safety
- City budget considerations
- Declining State financial support
- Political concerns

It is always beneficial to revisit existing procedures and evaluate possible changes. During snow season, the Maintenance Department should consider trying alternate methods of snow removal in test areas of the city and evaluate the pros and cons. One example might be clearing from the center and leaving berms on the edge of the curb to be pulled to the center for removal at a later date. The existing crew is the best resource for brainstorming additional alternate methods to evaluate.

City management should also consider the fact that current staffing levels have not increased in the last decade or longer, while new subdivisions and roads have been added to the work load. If the current level of public satisfaction is to be maintained or increased, then the need for additional resources should be evaluated.

Recent planning documents adopted by the City uniformly call for more attention to pedestrian or non-motorized access. Additional research indicates a high level of public satisfaction with street maintenance. There are some items that will benefit from additional consideration by the City.

- Review snow removal priorities, especially sidewalk and pedestrian access.
- Review staffing and equipment needed to increase pedestrian access.
- Explore scheduling of snow removal, especially around schools.
- Encourage the snow removal crews to experiment with alternate methods. The maintenance manager is the most knowledgeable individual available to explore the viability of possible changes and should be charged with testing options.
- Consider informing citizens and developers of driveway gate limitations for snow removal at wider driveways.
- Track snow events that result in snow berms remaining in center of streets overnight or longer, and review staffing if these events are more than occasional.
- Review the FMATS Seasonal Mobility Task Force document to see if possible private/public partnerships are a possibility.
- Review priorities and staffing for crack sealing to extend life of newer paved surfaces.
- Consider an increased budget line item for ongoing training of operators and maintenance supervisor.

### **3.2 When to Patch, Repave, or Reconstruct a Road**

The starting point for determining whether a road should be patched, rehabilitated, or fully reconstructed is based on the PASER scores. The PASER manual provides general guidelines on the course of action to take for each rating. However, an individual rating should not automatically dictate the final maintenance or rehabilitation technique.

Additional factors to consider when analyzing and comparing treatment options are: traffic projections, pavement age, pavement strength, construction limitations, and other limiting factors such as weather, curing times, or local issues that affect a specific treatment. The most desirable treatment should be the one that provides the greatest benefit (whether that benefit is measured in terms of improvement in condition, extension of pavement life, or even, more simply, the life of the treatment) for the lowest life-cycle costs.

Key factors that affect the selection of a pavement rehabilitation action and treatment are:

- Existing pavement (type, structure, condition, etc.)
- Environment (climate, traffic levels, etc.)
- Life-cycle costs (construction, maintenance, rehabilitation, user delay, etc.)
- Available treatments

In selecting the right preservation treatment, the condition of the existing pavement is important. Not only the overall condition, but also the specific distresses present on the pavement impact the selection of the proper preservation treatment. It is rare to encounter a single pavement condition, so where possible, these guidelines have considered the suitability of various treatments for combinations of pavement conditions.

Pavement conditions were evaluated in the City of Soldotna using the PASER system. Approximately 24 of Soldotna’s 31 miles (78%) of paved roads were classified with a rating of 6 or higher (good to very good), approximately 7 miles (21%) were classified with a rating of 4 or 5 (fair), and less than one mile (1%) was classified with a rating of 3 or less (poor to very poor).

Table 5 presents the types and likely causes of pavement distress found in Soldotna.

**Table 5 – Asphalt Distress Types and Likely Causes**

<b>Distress</b>	<b>Causes</b>	<b>Comments</b>
<b>Raveling and Weathering</b>	Loss of bond between the aggregate and binder. This may be due to insufficient asphalt cement content, poor adhesion of the asphalt cement to the aggregate, hardening of the asphalt cement, or segregation or inadequate compaction during construction.	Raveling results from loss of aggregate particles, weathering from loss of asphalt binder. Both may create safety hazards.
<b>Longitudinal Cracking</b>	Inadequate compaction at the edges of longitudinal paving lanes, reflection of underlying old pavement edges or cracks in a stabilized base, or application of heavy loads or high tire pressures in rutted wheelpaths.	Longitudinal cracking in rutted wheelpaths is more likely when heavy loads or high tire pressures are applied during cold weather to a rutted pavement with a weak subgrade.
<b>Block Cracking and Thermal Cracking</b>	Inability of asphalt binder to expand and contract with temperature cycles because of aging asphalt binder or poor choice of asphalt binder in the mix design.	Block cracking is aggravated by low traffic volume because the pavement may not densify sufficiently and may become brittle.
<b>Fatigue Cracking (also called Alligator Cracking)</b>	Fatigue damage in asphalt surface, base, or subgrade.	These cracks can progress to potholes. They begin first at locations where the underlying base and subgrade materials are weakest.
<b>Bumps, Heaves, and Settlement</b>	Foundation movement or localized consolidation likely resulting from inadequate compaction during construction.	In addition to detracting from riding comfort, at high severity these may pose a safety hazard.

Climatic conditions impact rehabilitation treatment usage in at least two ways: determining construction timing and affecting treatment performance. Some treatments, especially those using asphalt emulsions, can only be applied in limited temperature and humidity conditions.

The traffic level is important for at least two reasons. First, it is a direct measure of the loadings applied to a roadway. Second, it affects access to the roadway to perform preservation activities.

Traffic levels may also have an indirect relationship to risk tolerance: the more vehicles per day, the less likely the City is to try a treatment that may not have a long life or one that may adversely affect many users if it fails.

Regular traffic counts have not been carried out for the City of Soldotna. Therefore, traffic analysis was largely driven by zoning data and land uses for the parcels that road segments traveled through and connected. Roads were then classified as local (consistent with an estimated average daily traffic [ADT] of less than 1,500 vehicles), neighborhood collector (estimated ADT between 1,500 and 2,500), major collector (estimated ADT between 2,500 and 7,500), or minor arterial (estimated ADT greater than 7,500).

Table 6 presents a breakdown of the traffic classification and general condition of the 31 miles of paved streets the City manages.

Table 6 – PASER Scores by Functional Class

PASER	Functional Class				Total (%)
	Local Street <1,500 ADT	Neighborhood Collector 1,500-2,500 ADT	Major Collector 2,500-7,500 ADT	Minor Arterial ≥7,500 ADT	
<b>Good (6-10)</b>	13 miles	4 miles	6 miles	1 mile	78%
<b>Fair (4-5)</b>	4 miles	1 mile	2 miles	—	21%
<b>Poor (1-3)</b>	<1 mile	—	—	—	1%
<b>Total</b>	<b>17 miles</b>	<b>5 miles</b>	<b>8 miles</b>	<b>1 mile</b>	<b>100%</b>

Although treatment costs do not affect treatment performance, certain cost considerations are inevitably a part of the treatment selection process. The cost of each treatment depends on features such as the size and location of the project, severity and quantity of distresses, and the quality of a treatment’s constituent materials. It also depends on the type and amount of surface preparation work and the degree of traffic control required to apply or construct the treatment.

There are three basic steps in the pavement preservation treatment selection process:

- Collecting data
- Determining the feasible treatment techniques
- Analyzing and comparing the feasible options with each other

It is likely that several treatments will be feasible for any given road segment. When comparing different treatments, some thought should be given to the treatment placement cost, the life of the treatment, and whether or not the treatment extends the life of the pavement before full reconstruction becomes necessary.

The first step is to collect all the data necessary to evaluate the pavement’s present condition and rehabilitation needs, develop one or more rehabilitation treatments, predict the performance of each treatment, and estimate the cost of each treatment.

**Preventative, routine, and corrective maintenance** include activities such as crack sealing, patching, and applying seal coats to help slow the rate at which a paved surface deteriorates.

**Rehabilitation** involves work on the existing pavement, followed by an overlay. Work on the existing surface may include planing the surface smooth, patching, and filling cracks.

This work typically brings the PASER score back up to 9; however, its performance is dependent on the quality of the work done.

**Pavement reconstruction** includes at least removal and replacement of the existing pavement. If this is needed earlier than expected, then improvement of the structural section is warranted. That may include increasing the pavement thickness and/or stabilizing the base and subbase materials. This type of project work will bring the PASER score back up to 10.

**Table 7 – Rehabilitation Techniques for Specific Asphalt Pavement Distresses**

Asphalt Pavement Distress	Partial Depth Repair	Full Depth Repair	Thin Overlay <2 inches)	Structural Overlay (≥2 inches)	Full-Depth Reclamation with ≥2 inches HMA	Reconstruction
Raveling / Weathering			✓	✓	✓	✓
Rutting			✓	✓	✓	✓
Reflection Cracking	✓	✓	✓	✓	✓	✓
Slippage Cracking	✓		✓ <sup>1</sup>	✓	✓	✓
Longitudinal Cracking		✓		✓	✓	✓
Block Cracking	✓		✓	✓	✓	✓
Fatigue (Alligator) Cracking		✓ <sup>1</sup>		✓	✓	✓
Patches			✓	✓	✓	✓
Potholes	✓ <sup>2</sup>	✓		✓	✓	✓
Bumps, Heaves, Settlements		✓			✓	✓

<sup>1</sup> Suitable for isolated or limited occurrences of this distress

<sup>2</sup> Effectiveness depends on depth of damage

The most important factors to consider when choosing a rehabilitation treatment include:

- Will the treatment address the distresses present? (i.e., Will it work?)
- Can the required preparation for the treatment be carried out?
- Is the treatment cost effective using life-cycle cost analysis or other approaches?
- Will the treatment be performed before the situation being addressed changes?

Allowing roads to deteriorate over time costs significantly more than maintaining roads in good condition. The cost to reconstruct a 25-year-old roadway can be more than three times what it would have cost to “maintain” it using a sequence of preservation treatments over the same 25 years (Peshkin et al. 2011). Hence, long-term cost-effectiveness is a critical component in the selection of appropriate treatments at any traffic level.

Table 8 – Relative Rehabilitation Treatment Costs

Treatment	Relative Cost (\$ to \$\$\$\$)
Crack Filling	\$
Crack Sealing	\$
Partial Depth Repair	\$\$
Full Depth Repair	\$\$ / \$\$\$
Thin Overlay (<2 inches)	\$\$ / \$\$\$
Structural Overlay (≥2 inches)	\$\$\$
Full Depth Reclamation with ≥2 inches HMA	\$\$\$ / \$\$\$\$
Reconstruction	\$\$\$\$

Note: \$ = low cost; \$\$ = moderate cost; \$\$\$ = high cost; \$\$\$\$ = very high cost.

Rehabilitation treatments may also have costs or benefits which cannot be measured in monetary terms. For example, a road rehabilitation project may temporarily limit access to schools and businesses, impede traffic within a certain corridor, or bring about undesirable environmental consequences. The City of Soldotna should consider all economic and non-economic criteria in weighing the total “cost” of a roadway rehabilitation treatment.

Criteria that should be considered include:

- Geometric restrictions
- Local economy
- Traffic safety
- Environmental impact
- Worker safety
- Availability of equipment and materials
- Political concerns

By incorporating these contextual factors into valuations and cost comparisons, the City’s maintenance department can enhance the sustainability of its efforts by ensuring that road improvements remain politically palatable, environmentally sound, and able to support the operation and growth of local businesses and enterprises.

To select the most cost-effective rehabilitation strategy, the City of Soldotna should consider all costs and benefits that will be incurred as a result of implementing that strategy. Not all rehabilitation strategies result in the same added performance or longevity for the resulting pavement. When comparing the full life-cycle costs of rehabilitation strategies, the Federal Highway Administration (FHWA) recommends an analysis period of 35 years or more (Walls et al. 1998)

Under typical conditions in Alaska, paved roadways will see a 40% drop in quality over the first 15 years, while the next 40% drop occurs over the next 2.5 years. Therefore, every dollar spent on preventative maintenance when pavement quality is still fair can delay the need to expend five to ten dollars for major rehabilitation or reconstruction (see Figure 9).



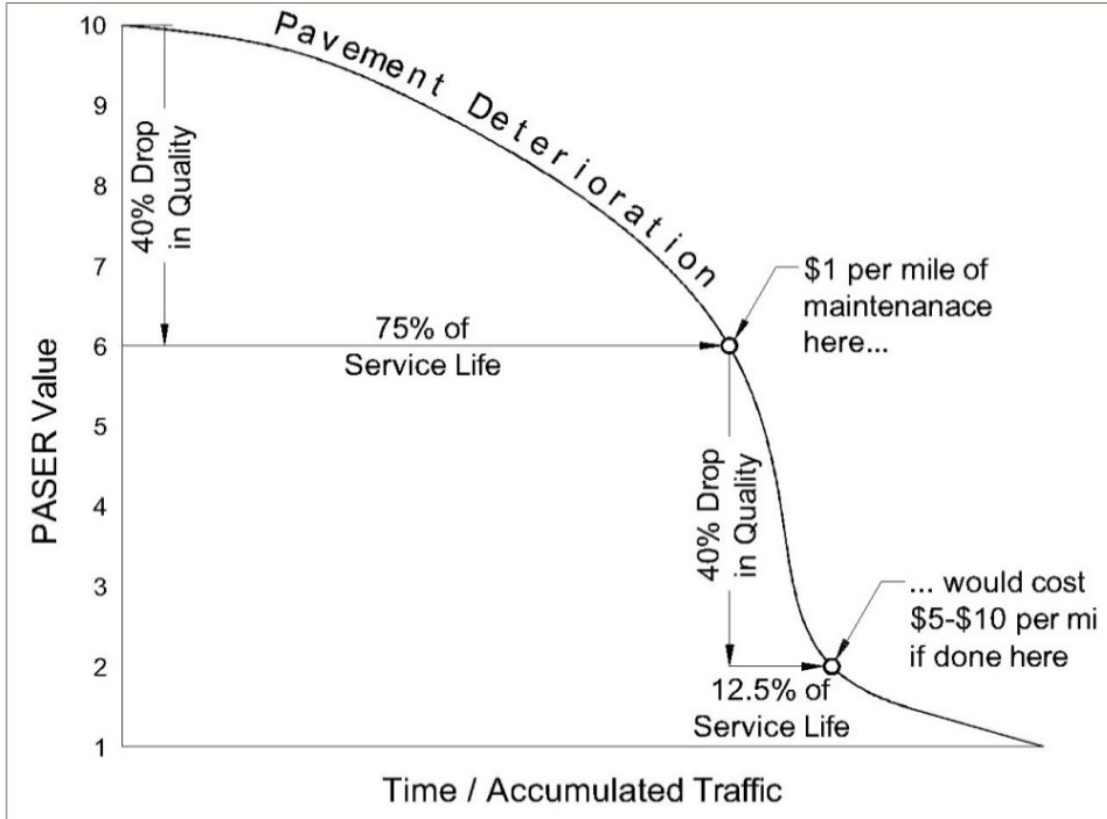

Figure 9 – Conceptual Timeline of Pavement Degradation

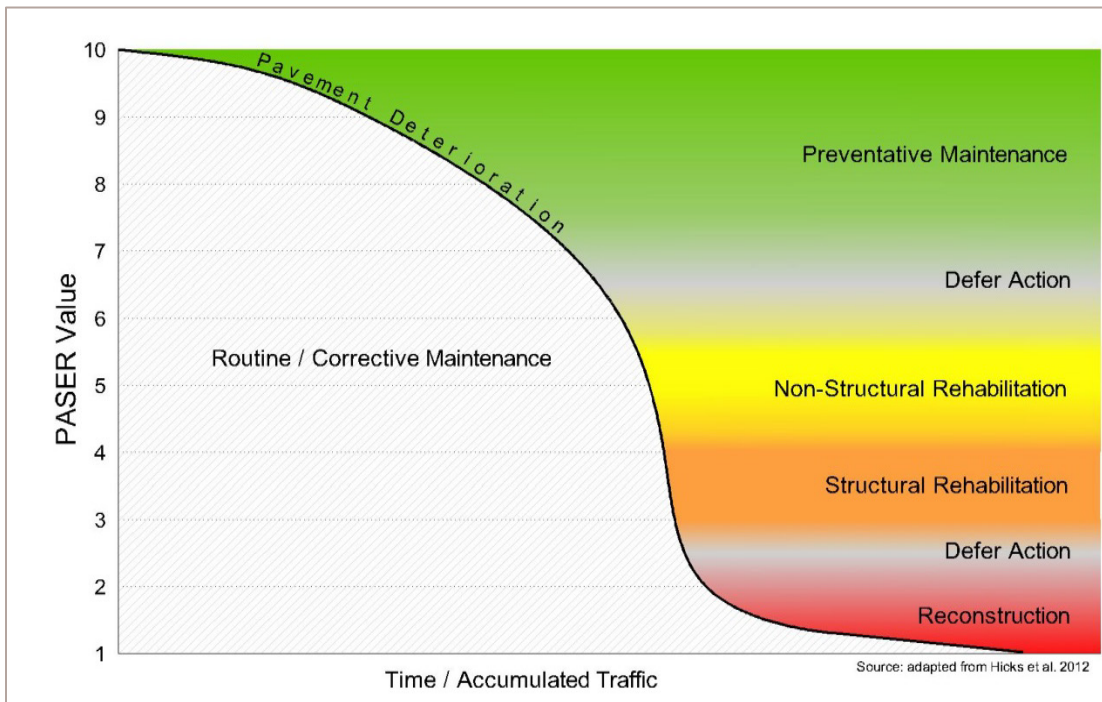

Figure 10 – Recommended Pavement Management Strategy

The application of the **right treatment** to the **right pavement** at the **right time** is the essence of a cost-effective pavement preservation program. Figure 10 illustrates a recommended pavement management strategy that may assist the City of Soldotna with determining appropriate combinations of treatment, condition, and age of pavement.

All candidate pavement preservation/rehabilitation treatments compete for the same budget, with the “winner” representing the best cost-effective method of providing pavement infrastructure. The winner may be a single treatment or a combination of treatments.

### 3.3 When to Pave a Gravel Road

Upgrading a gravel road to a paved surface is a significant cost. So how can the City of Soldotna determine when it's time to pave a gravel road? This section provides guidance for answering that question with justification in the form of cost analysis, land use considerations, and traffic volumes.

The City of Soldotna maintains approximately 11 miles of gravel roads (see Figure 11).

#### 3.3.1 *Why Would You Want To Pave a Gravel Road?*

Paving a gravel road can have many benefits, including:

- Improved safety from improved signage and striping
- Higher user satisfaction due to the smoother surface
- Lower user costs/less vehicle maintenance
- Increased property values for parcels adjacent to the road
- Reduced maintenance costs for the City
- Health benefits of dust reduction
- Opportunities to construct dedicated pedestrian facilities
- Economic development due to improved access

The conversion from gravel to pavement can also have some other consequences that need to be considered, such as:

- Higher travel speeds
- Increase in traffic volume
- Change in traffic type (e.g., more trucks)
- Need for higher geometric standards
- Changes in the aesthetics of an area

While there is an abundance of guidance available from a number of research institutions throughout the country, there are no established rules that dictate when roads should be paved. Instead, the decision to pave rests more with local expectations of convenience and usability.

There are two primary financial considerations when making the decision to pave a gravel road – the cost of road maintenance and the cost of the upgrade. These costs are summarized in the following sections.



Gravel roads

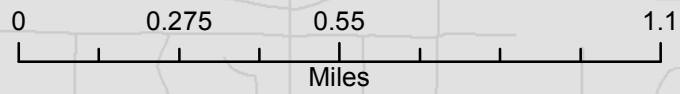

*[This page intentionally left blank.]*

### **3.3.2 What Are the Costs Associated with Maintaining a Gravel Road?**

Maintenance of gravel roads includes activities such as:

- Blading the road surface
- Pulling ditches to recover gravel and fines to remix with road surface material
- Applying dust palliative
- Plowing snow
- Adding gravel to replace worn-away surface material

Recent studies in Minnesota and South Dakota have shown that the maintenance costs for a high-volume gravel road are greater than for high-volume asphalt roads. This is because of more lost gravel due to wear and an increased need for blading and smoothing the road surface. Both studies found that maintenance costs for gravel roads increased significantly once ADT levels start exceeding 150 to 200 vehicles.

In Soldotna, gravel roads comprise only 26% of the city's total road network, yet they consume approximately 52% of the maintenance department's time and resources during the summer. This is due to time spent on grading, ditch clearing, and application of dust palliatives. Winter maintenance costs for gravel roads are comparable to those for rural paved roads. Roads in densely populated areas, especially those with sidewalks, require additional snow removal and snow hauling.

During a typical year, the City of Soldotna spends approximately \$28,350 per mile to maintain gravel roads, as compared with an annual cost of approximately \$20,550 per mile for paved roads. Many of the street maintenance costs are fixed—salaries, equipment, fuel, etc.—and averaged over the relatively low numbers of road miles, the costs per mile seem fairly high until compared with studies in other regions. A recent Sacramento area transportation plan (MTP 2035) documented routine preventative maintenance costs at an average of \$15,000 per mile per year. The Texas Transportation Institute estimates a cost of \$20,000 per mile per year to complete effective preventative maintenance including crack sealing, pothole repair, and drainage. Neither of these locations receives measurable annual snowfall. There is limited published information on cost per mile under snow and ice conditions. However, review of local budget documents from Lower 48 communities with similar snowfall and population supports the statement that Soldotna maintenance costs are only slightly higher than average. A more consistent metric for evaluating snow removal costs and general maintenance appears to be population density. Figure 7 compares street maintenance costs for Alaska communities ranked by population density. Those with higher population densities have higher per mile costs due to a variety of reasons, including the need to haul snow, use of snow gates, deicing, and maintenance of pedestrian access. Therefore, it is important to remember that conversion of a gravel road to a paved road doesn't result in a direct reduction of \$7,800. Likewise, adding gravel or paved roads to the City's network wouldn't result in a direct cost increase of \$28,350 or \$20,550 per mile, respectively.

The City of Soldotna is in the process of implementing a software tracking program for maintenance, fleet costs, and work orders. Once fully implemented, this software will enable the City to closely track costs and cost centers. In the meantime, the estimates in this memo are based on FY16 budgeted maintenance costs and discussions with maintenance staff.

One of the factors contributing to the high cost of maintaining gravel roads is the fact that many of them are isolated. Gravel roads that are surrounded by paved roads or those that are located in out-of-the-way areas are inefficient to maintain because the City must gear up specifically for gravel maintenance activities for that one area.

**3.3.3 What Drives the Cost of an Upgrade from Gravel to Pavement?**

Converting a gravel road to pavement isn’t as simple as laying asphalt over the existing surface. Several factors must be considered, including:

- Geology/soil conditions
- Drainage and stormwater management
- Existing or potential utility system connections
- Right-of-way (ROW) width
- Original construction

The costs associated with each of these considerations can have a significant impact on the overall cost of converting from gravel to pavement. For example, urban roads generally require the collection of stormwater via a piped network whereas rural roads rely on ditches for water collection and retention. The need for a piped stormwater system can add significantly to the project cost (see Table 9).

Recent gravel-to-pavement projects in Soldotna have ranged in cost from \$300,000 to over \$1,000,000. Table 9 breaks down major elements of those projects to help highlight the impact that utilities can have. It is important to note that while costs appear high, by combining road and utility construction projects whenever possible there is an overall savings in construction costs.

**Table 9 – Recent Gravel-to-Pavement Projects in Soldotna**

<b>Project</b>	<b>Total Construction Cost</b>	<b>Storm Drains</b>	<b>Utilities</b>	<b>Road Construction</b>	<b>Project Length (ft)</b>
<b>Porcupine</b>	\$299,057	\$69,265	\$8,700	\$221,092	781
<b>N. Aspen</b>	\$648,570	\$52,785	\$212,363	\$383,422	860
<b>Sterling</b>	\$1,073,193	\$62,520	\$529,388	\$481,285	1,611

The prices of commodities such as oil also play a role in the cost to pave a gravel road. When oil prices are low, asphalt and fuel are less expensive. The longer the segment of road being paved, the greater the impact that commodity prices will have on construction cost. To reduce the construction costs of converting a gravel road to pavement, alternative surfacing options can be considered. Examples are Recycled Asphalt Pavement (RAP) and chip seal. Both of these materials provide a hardened road surface with qualities similar to an asphalt surface. Table 10 highlights the major differences between them.

**Table 10 – Alternative Surfacing Materials Comparison**

	<b>Recycled Asphalt Pavement</b>	<b>Chip Seal</b>
<b>Pros</b>	Similar characteristics to asphalt	Good option for overlaying an old paved surface
<b>Cons</b>	Quality can be highly variable depending on machine used to rotomill	Rougher surface than RAP or asphalt

There are other elements to consider when converting a gravel road to pavement that are not easily quantifiable. Many of these are listed above and relate to user convenience and other intangible considerations. Generally, these intangibles can be placed in two categories:

- Costs/benefits to the public
- Economic costs/benefits

The benefits to the public, such as reduced vehicle maintenance, are difficult to quantify and do not result in additional revenue to the City. However, the quality of life is generally improved, particularly if the conversion to pavement results in less dust on neighboring properties or if new sidewalks can be added with the conversion. Costs to the public may come in the form of vehicles traveling faster through a neighborhood or an increase in traffic through a neighborhood if the newly paved street provides a smoother alternative to an existing route. Also, residents may feel that the character of a neighborhood will change if the road is paved.

Potential economic benefits to the city are generally not realized immediately and are often difficult to calculate. Paving gravel roads can lead to new residential or commercial construction that will add to the city’s property tax base sometime in the future. How much property tax revenue the city will receive depends on the value of the construction and the tax rates.

**3.3.4 Determining When to Pave a Gravel Road**

Based on the research presented above and the conditions in Soldotna, we recommend the following guidelines as a basis for determining when to pave a gravel road. While each potential gravel-to-pavement project should be evaluated independently, these guidelines provide benchmarks for determining potential projects.

- **Monitor Traffic Volumes:** When traffic volumes on gravel roads reach 150 vehicles per day, the city should begin considering an upgrade to pavement. This threshold provides time to analyze, design, finance, and construct the road before traffic volumes exceed 200 vehicles per day.
- **Evaluate Growth Potential:** Analysis should include an assessment of the future growth potential of an area, as well as the potential economic benefits that paving may have. Areas with limited growth potential, such as built-out subdivisions, may not warrant paving, whereas undeveloped or partially developed areas could be built up faster if the local roads were paved, thereby providing additional property tax revenue sooner.

- **Identify Isolated Segments:** Isolated segments of gravel road, particularly very short segments that are surrounded by paved streets, should be paved. This will improve City M&O efficiency and reduce expenses. An example is Lord Baranof Street, a segment of gravel road less than 400 feet long that is surrounded by paved city streets.
- **Assess Public and Stakeholder Sentiment:** The public or stakeholders (e.g., school district, emergency services) may encourage the city to pave certain streets for various reasons. By monitoring public and stakeholder sentiment, the city may identify segments of gravel roads where paving is warranted even if the criteria above are not met.

### 3.4 Typical Sections

Several factors, including road function and traffic volume, subgrade soils, and pedestrian/bicycle usage, contribute to development of recommended typical sections. Per the U.S. Department of Agriculture (USDA) Soil Survey, the underlying soils in the city core are primarily gravel; soils outside the city core are silty-loam and silt. Areas of peat are identified on the south side of East Redoubt. With the exception of the areas of peat, the subgrade soils are generally suitable to support roadways.

The existing structural section provided in the 1985 Standard Specifications is performing well and is recommended. This structural section is not recommended in areas underlain with deep peat layers. In those areas, a geotechnical investigation and evaluation by an Engineer is recommended to determine the appropriate section for the situation.

The City has a high volume of pedestrian and bicycle traffic. Incorporating shared use into the road system is a priority.

The continued incorporation of bike lanes in Minor Arterial and Major Collector classified roads is recommended. FHWA recommends a minimum width of 4 feet for bike lanes bounded by curb and gutter.

Sidewalks are recommended on both sides of the street for Minor Arterial and Major Collectors and on one side of the road for Neighborhood Collectors. The added cost of sidewalks is not recommended for Local Roads, with their low ADT and low speeds. To meet the latest accessibility guidelines, a minimum sidewalk width of 5 feet is recommended with wider sidewalks where possible. In constrained situations, a minimum sidewalk width of 4 feet is permissible if passing areas are provided at intervals of 200 feet or less.

The recommended typical sections provided are applicable to the overall conditions found in the City of Soldotna – see Appendix B. Engineering judgment should be used when applying these typical sections to non-typical situations.

Table 11 – Existing vs. Proposed Section Comparison

<b>Functional Class (Former Functional Class)</b>	<b>Element</b>	<b>Existing</b>	<b>Proposed (urban)</b>	<b>Proposed (rural)</b>
<b>Local Road (Residential Minimum Development)</b>	Lane Width	12'	12'	12'
	Sidewalk	No	No	No
	Center Turn Lane	No	No	No
	Curb & Gutter	Standard	Rolled	n/a
<b>Neighborhood Collector (Residential Full Development)</b>	Lane Width	12'	12'	12'
	Sidewalk	4'	5' (one side)	No
	Center Turn Lane	No	No	No
	Curb & Gutter	Standard	Standard	n/a
<b>Major Collector (Collector Full Development)</b>	Lane Width	12'	12'	12'
	Sidewalk	4'	5'	No
	Bike Lane	3'	4'	5'
	Center Turn Lane	11'	No	No
	Curb & Gutter	Standard	Standard	n/a
<b>Minor Arterial (Collector Full Development)</b>	Lane Width	12'	11'	n/a
	Sidewalk	4'	5'	
	Bike Lane	3'	4'	
	Center Turn Lane	11'	11'	
	Curb & Gutter	Standard	Standard	

*[This page intentionally left blank.]*



## 4 RECOMMENDATIONS

The following recommendations are based on the inventory and assessment of city streets, review of city budgets and policies, and best practices. While the recommended capital projects are listed with target dates, these should be considered flexible and subject to change according to funding availability, potential to lump or split projects, and related projects (e.g. sewer rehabilitation).

Cost estimates developed at this planning stage can vary dramatically from final costs and are presented only to show order-of-magnitude construction costs. These estimates also do not include a number of factors, described below, that can influence overall project costs:

- Right-of-way acquisition and utility relocations, if needed, can be costly (sometimes exceeding the cost of construction)
- Detailed engineering design costs are typically in the range of 8 to 12% of construction costs
  - Actual engineering design of a project may require substantial changes to certain features, such as accommodations for drainage or driveways
  - Additional traffic analysis may be required
- Some degree of traffic control (e.g., flaggers) will be needed during construction
- Public involvement efforts will be required in order to ensure fair consideration of the needs of local residents, property owners, and other stakeholders the project will affect
  - Special Assessment Districts (SADs) will require more intensive outreach to local property owners

The recommendations in this plan should also be cross-referenced with other City of Soldotna planning documents such as the Comprehensive Plan, Safe Routes to School plan, and Downtown Improvement Plan. Reviewing all of the plans in combination will provide a clear vision of items to consider when rehabilitating a street, such as signage, streetscaping improvements, and pedestrian facilities.

### 4.1 Prioritization Process

The Boston Metropolitan Area Council has developed a formula for prioritizing street improvements. The formula for the prioritization (slightly modified to take advantage of the PASER number developed in this study and to eliminate truck impacts) is:

$$\text{Priority Score} = 100 * (\text{Traffic Volume}/\text{PASER Rating})$$

This formula prioritizes streets with higher traffic volumes. Traffic volumes are an important part of the priority development, but precise counts were not available. To account for that, each street's functional classification was assigned a numeric value to serve as a proxy for traffic volume. Table 12 lists the numeric values that were used for each functional classification.

**Table 12 – Traffic Volume Factors by Functional Classification**

Functional Class	Traffic Volume Factor
Minor Arterial	7
Major Collector	4
Neighborhood Collector	3
Local	1

Applying this formula to the Soldotna city streets results in priority scores between 10 and 100, with the higher scores indicating higher priority. To differentiate between maintenance and reconstruction projects, PASER values of 6 or greater were considered preventive maintenance, while PASER values of less than 6 were considered capital improvements. Figure 12 illustrates the extent of preventive maintenance projects versus capital improvement projects. Because the City maintenance department has done such a thorough job of maintaining the street network, there are relatively few capital projects.

Figure 13 shows the preventive maintenance priorities. Consistent with the guidelines outlined in Section 3.1 above, the city should focus preventive maintenance activities on those streets with higher traffic volumes.

#### 4.2 Maintenance

The City should continue with its program of crack sealing for paved roads, regrading for gravel roads, and ditch clearing. The high-priority streets for maintenance activities (also shown on Figure 13) include:

- Binkley Street
- Marydale (west of Kenai Spur Hwy.)
- West Redoubt to Memorial Park
- East Redoubt to Classic
- Kobuk (Sterling Hwy. to Kobuk Ct.)
- Birch Street
- East Corral
- Karen Street

Newer asphalt should be maintained according to the general guidelines in Table 13.

**Table 13 – General Guidelines for Maintaining New Asphalt**

Timeline	General Pavement Condition	Preventative Maintenance
0–2 years	<ul style="list-style-type: none"> <li>• New, like new</li> </ul>	<ul style="list-style-type: none"> <li>• Should require little to no maintenance. Cracks over ¼ inch wide should be sealed and then resealed annually thereafter.</li> </ul>
2–8 years	<ul style="list-style-type: none"> <li>• Less than 50% of surface is cracked</li> <li>• Cracks open ¼ to ½ inch</li> <li>• No signs of structural distress<sup>1</sup></li> </ul>	<ul style="list-style-type: none"> <li>• Annual crack sealing; focus on high-volume roads first.</li> </ul>
8–12 years <i>(or when annual crack sealing is no longer cost-effective)</i>	<ul style="list-style-type: none"> <li>• Over 50% of the surface is cracked</li> <li>• Less than 50% attributed to block cracking</li> <li>• Cracks open ½ inch</li> </ul>	<ul style="list-style-type: none"> <li>• Discontinue crack sealing. Apply seal coat. Plan to mill and pave within 1 to 3 years.</li> <li>• Seal coat not recommended on high-volume roads or roads that have poor skid resistance.</li> </ul>

<sup>1</sup> Structural distress: alligator cracks, longitudinal cracks in wheel path, more than 50% of surface has block cracks

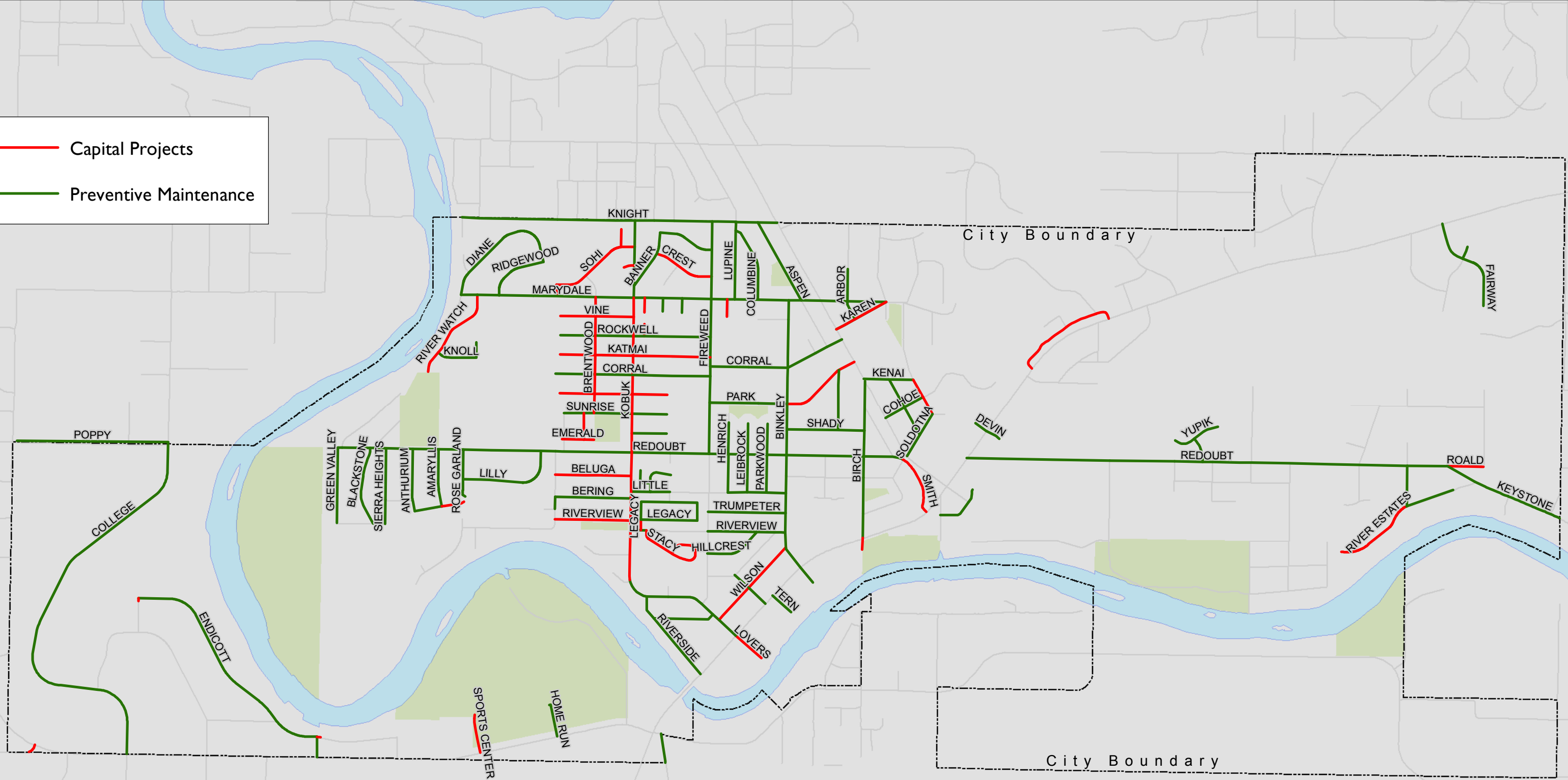
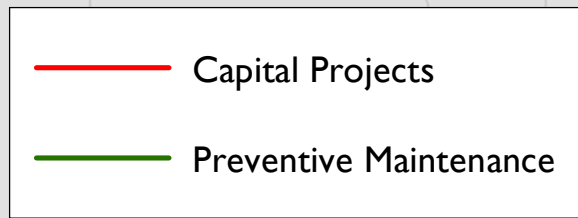

FIGURE	MAR 2016	SOLDOTNA STREETS INVENTORY AND MANAGEMENT PLAN
<b>12</b>	PROJECT No. <b>15050FB</b>	<b>PREVENTIVE MAINTENANCE &amp; CAPITAL IMPROVEMENT PROJECTS - PAVED STREETS</b>



*[This page intentionally left blank.]*

# Priority Score

- < 25 - Low Priority
- 26 - 50
- 51 - 75
- > 75 - High Priority

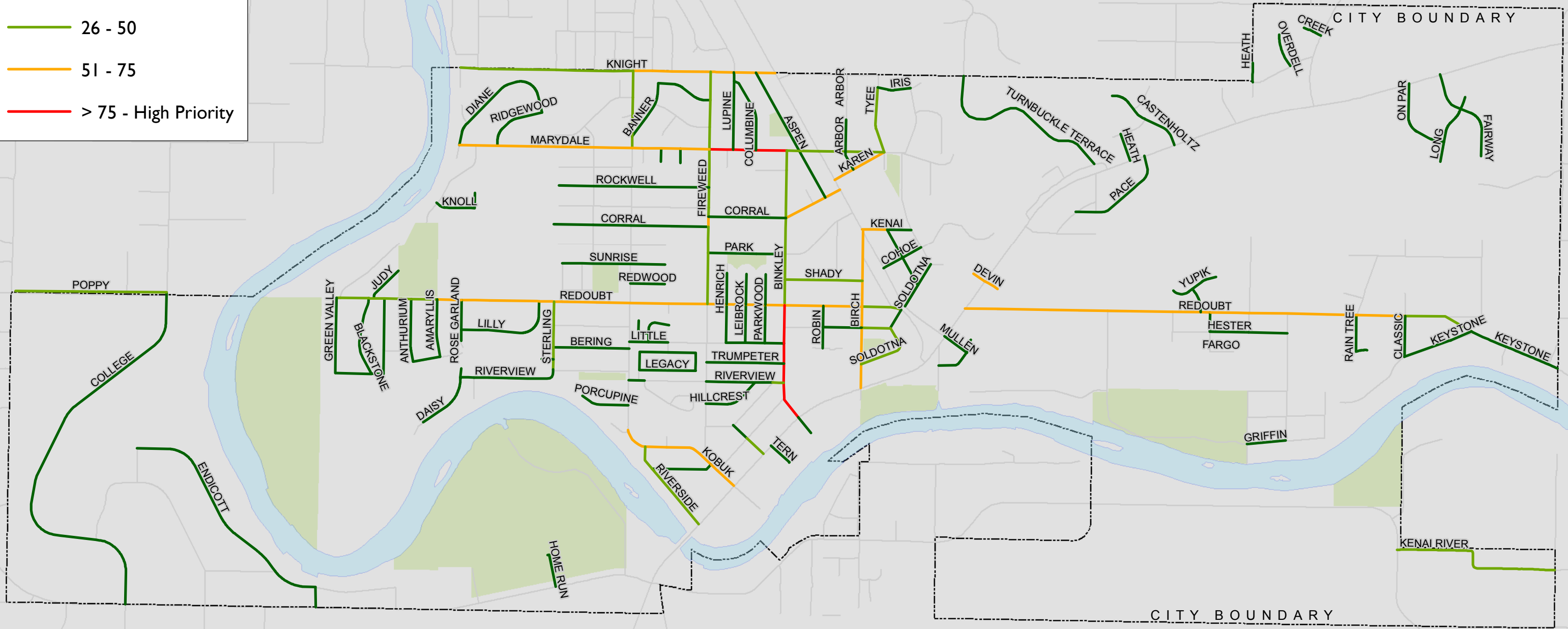

FIGURE

MAR 2016

SOLDOTNA STREETS INVENTORY AND MANAGEMENT PLAN

**13**

PROJECT NO.

**15050FB**

**PREVENTIVE MAINTENANCE PRIORITIES**



PDC INC. ENGINEERS

*[This page intentionally left blank.]*

Additional maintenance recommendations:

- Review snow removal priorities, especially sidewalk and pedestrian access.
- Review staffing and equipment needed to increase pedestrian access.
- Explore scheduling of snow removal, especially around schools.
- Encourage the snow removal crews to experiment with alternate methods. The maintenance manager is the most knowledgeable individual available to explore the viability of possible changes and should be charged with testing options.
- Consider informing citizens and developers of driveway gate limitations for snow removal at wider driveways.
- Track snow events that result in snow berms remaining in center of streets overnight or longer, and review staffing if these events are more than occasional.
- Review the FMATS Seasonal Mobility Task Force document to see if possible private/public partnerships are a possibility.
- Review priorities and staffing for crack sealing to extend life of newer paved surfaces.
- Consider an increased budget line item for ongoing training of operators and maintenance supervisor.
- Consider purchase of an infrared pavement repair machine to facilitate pavement repairs without incurring the cost of using a contractor
- Evaluate the use of liquid de-icing of roundabouts to improve driver safety during the winter
- Hire two additional temporary maintenance employees in the summer to assist with on-going maintenance activities; these seasonal employees could be shared with the Parks & Recreation department

### 4.3 Capital Improvements

Based on the results of the prioritization analysis, discussions with City staff, and review of pavement ages, the following capital improvements are recommended. The planning-level cost estimates for near-term projects include:

- Engineering design
- Contractor mobilization & demobilization
- Construction administration
- Traffic control
- Sidewalk repairs (as needed)
- Curb and gutter (as needed)
- Erosion and sediment control plan
- Asphalt
- Contingency estimate

**Table 14 – Near-Term Capital Improvement Projects**

<b>Project</b>	<b>Year</b>	<b>Cost Estimate</b>	<b>Type</b>
<b>S. Kobuk Street Rehabilitation</b>	2017	\$415,000	Reconstruct/rehabilitate
<b>Lord Baranof Street Paving</b>	2017	\$390,000	Gravel-to-pavement
<b>N. Kobuk Street Rehabilitation</b>	2018	\$640,000	Reconstruct/rehabilitate
<b>Brentwood Street Rehabilitation</b>	2018	\$ 30,000	Reconstruct/rehabilitate
<b>Smith Way Rehabilitation</b>	2019	\$200,000	Reconstruct/rehabilitate
<b>E. Park Avenue Rehabilitation</b>	2019	\$ 80,000	Reconstruct/rehabilitate
<b>Sharkathmi Avenue Paving</b>	2020	\$410,000	Gravel-to-pavement

**Table 15 – Long-Term Capital Improvement Projects**

<b>Project</b>	<b>Timeframe</b>	<b>Type</b>
<b>S. Fireweed Street / Reger Avenue Rehabilitation</b>	6-10 years	Reconstruct/rehabilitate
<b>Harbor Terrace Lane / Oehler Drive Rehabilitation</b>	6-10 years	Reconstruct/rehabilitate
<b>Jay Street Rehabilitation</b>	6-10 years	Reconstruct/rehabilitate
<b>W. Riverview Avenue / W. Beluga Avenue Rehabilitation</b>	6-10 years	Reconstruct/rehabilitate
<b>Arlington / Katmai / Vine Rehabilitation</b>	11-20 years	Reconstruct/rehabilitate
<b>Sohi Lane / Crest Drive Rehabilitation</b>	11-20 years	Reconstruct/rehabilitate
<b>Artifact / Brooks / Chugach Paving</b>	11-20 years	Gravel-to-pavement
<b>Swiftwater Park Rehabilitation</b>	11-20 years	Reconstruct/rehabilitate
<b>Linda Lane Paving</b>	11-20 years	Gravel-to-pavement
<b>Riverwatch Drive Rehabilitation</b>	11-20 years	Reconstruct/rehabilitate
<b>Northeast rural roads rehabilitation (Monte, Cahill, Bogie, John Henry)</b>	11-20 years	Reconstruct/rehabilitate



# Priority Score

- < 25 - Low Priority
- 26 -50
- 51 - 75
- > 75 - High Priority

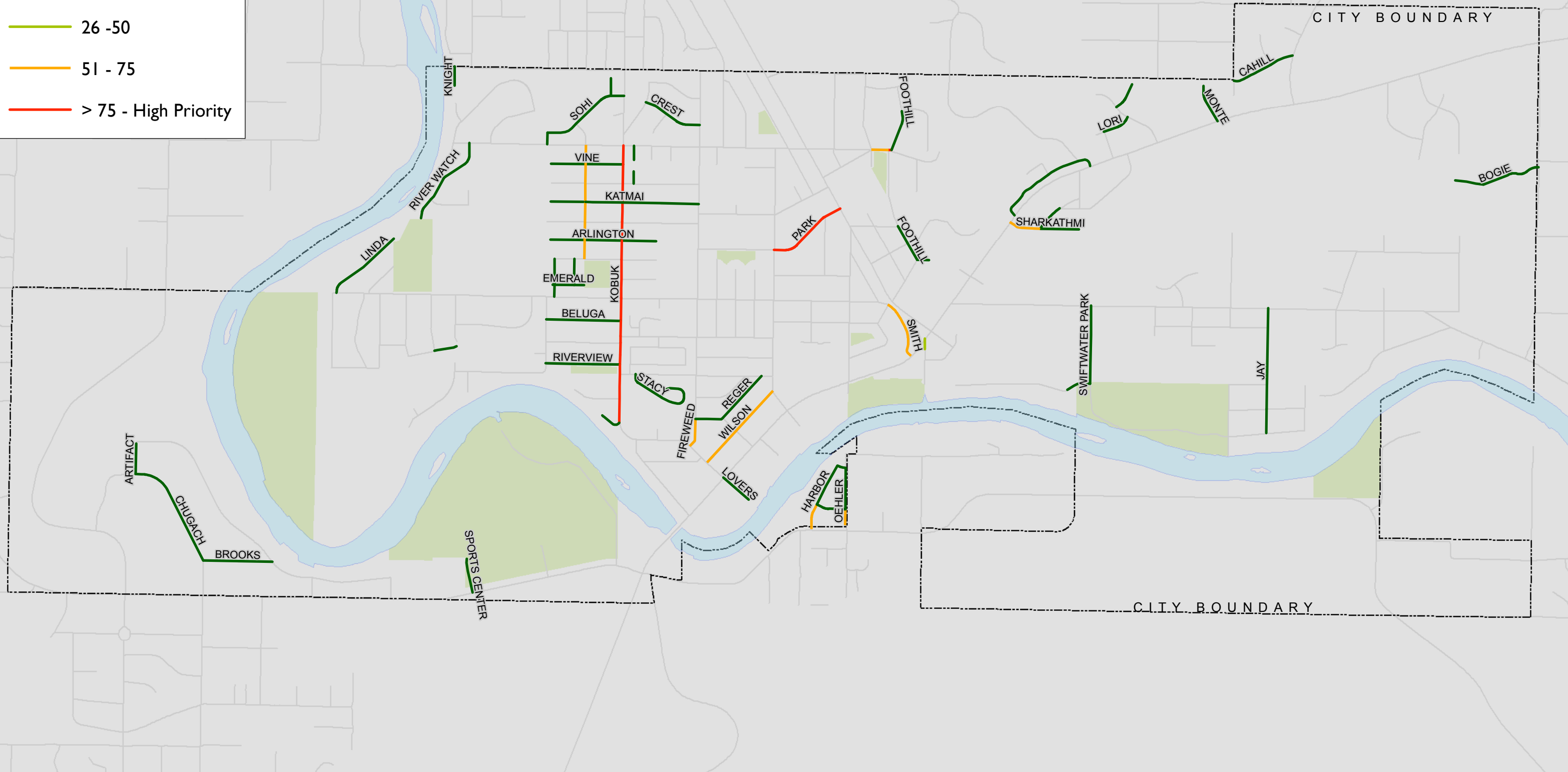

FIGURE

MAR 2016

SOLDOTNA STREETS INVENTORY AND MANAGEMENT PLAN

PROJECT NO.

**14**

**15050FB**

**CAPITAL IMPROVEMENT PRIORITIES**



*[This page intentionally left blank.]*

### 4.3.1 Funding

Funding for capital projects can come from several sources:

- **Special Assessment Districts (SAD):** Residents of a particular geographic area pay a fee to fund the construction of a capital improvement that would directly benefit them. The City of Soldotna's process for developing a SAD was adopted by Ordinance 2012-022.
- **State General Funds:** State legislators can allocate state funds to a particular capital improvement project pending legislative approval. The current financial situation of the state has limited the availability of this type of funding.
- **Federal Funds:** Funding is available through several FHWA programs, including the Highway Safety Improvement Program (HSIP), Congestion Mitigation and Air Quality (CMAQ), Surface Transportation Block Grant (STBG), and Transportation Alternatives Program (TAP). DOT&PF administers FHWA funding throughout Alaska; capital improvement projects are nominated by DOT&PF staff and scored against a variety of criteria to determine which projects will receive funding.

### 4.3.2 Projects Recommended for the Near Term

#### South Kobuk Street Rehabilitation

**Recommended Year:** 2017

**Cost Estimate:** \$415,000

**PASER Rating:** 5

**Pavement Age:** 30 years

**Functional Class:**  
Major Collector

**Description:**  
Mill and pave South Kobuk Street from Kobuk Court north to Redoubt Avenue; shallow patching at intersections with Porcupine Street and Bering Avenue; bring sidewalks into compliance with the accessibility requirements of the Americans with Disabilities Act (ADA); replace sidewalk sections that are failing; re-stripe.



Figure 15 – South Kobuk Street

## Lord Baranof Street Paving

**Recommended Year:** 2017

**Cost Estimate:** \$390,000

**PASER Rating:** 4

**Pavement Age:** N/A – Gravel

**Functional Class:** Local Road

**Description:**

Pave the segment of Lord Baranof Street between Emerald Avenue and W. Sunrise Avenue. While this is a low volume, local road, this segment of gravel road is isolated from other gravel roads and is inefficient for the city to maintain.



Figure 16 – Unpaved Segment of Lord Baranof Street

## North Kobuk Rehabilitation

**Recommended Year:** 2018

**Cost Estimate:** \$640,000

**PASER Rating:** 4

**Pavement Age:** 30 years

**Functional Class:** Major Collector

**Description:**

Mill and pave North Kobuk Street from Redoubt Avenue north to Marydale Street; shallow patching at intersection with Sunrise Avenue; bring sidewalks into ADA compliance; re-stripe.



Figure 17 – N. Kobuk Street



---

## Brentwood Street Rehabilitation

**Recommended Year:** 2018

**Cost Estimate:** \$30,000

**PASER Rating:** 5

**Pavement Age:** 30 years

**Functional Class:** Neighborhood Collector

**Description:**

Apply sealcoat along the entire length of Brentwood Street.



Figure 18 – Brentwood Street

---

## Smith Way Rehabilitation

**Recommended Year:** 2019

**Cost Estimate:** \$200,000

**PASER Rating:** 5

**Pavement Age:** 30 years

**Functional Class:**  
Neighborhood Collector

**Description:**

Mill and pave the entire length of Smith Way; bring sidewalks into ADA compliance; re-stripe.



Figure 19 – Smith Way

## East Park Avenue Rehabilitation

**Recommended Year:** 2019

**Cost Estimate:** \$80,000

**PASER Rating:** 5

**Pavement Age:** 30 years

**Functional Class:**  
Major Collector

**Description:**  
Sealcoat the entire length of East Park Avenue; bring sidewalks into ADA compliance.



Figure 20 – East Park Avenue

## Sharkathmi Avenue Paving

**Recommended Year:** 2020

**Cost Estimate:** \$410,000

**PASER Rating:** 4

**Pavement Age:** N/A – Gravel

**Functional Class:** Neighborhood Collector

**Description:**  
Pave Sharkathmi Avenue from the Sterling Highway to John Henry Drive; no curb and gutter.

Sharkathmi Avenue sees heavier than average traffic for a neighborhood collector because it provides access to a popular restaurant. Paving the street will reduce maintenance costs and provide a higher-quality user experience.



Figure 21 – Sharkathmi Avenue

## 5 REFERENCES

DOWL HKM (2011), *Envision Soldotna 2030 Comprehensive Plan*.

Peshkin, D., Hoerner, T., Zimmerman, K. (2004), Optimal Timing of Pavement Preventive Maintenance Treatment Applications, *NCHRP Report No. 523*, Transportation Research Board, Washington, D.C.

Peshkin, D., Smith, K.L., Wolters, A., Krstulovich, Moulthrop, J., Alvarado, C. (2011), Guidelines for the Preservation of High-Traffic-Volume Roadways, *SHRP 2 Report S2-R26-RR-2*, Transportation Research Board, Washington, D.C.

Walls, J., Smith, M. (1998), Life-Cycle Cost Analysis in Pavement Design, *FHWA-SA-98-079*, Federal Highway Administration, Washington, D.C.

*[This page intentionally left blank.]*



---

---

**APPENDIX A**

**PUBLIC COMMENTS**

---

---



Comment #	Street	Comment	Creation Date	Edit Date	Comments by Category
1	Chugach Drive	Not paved, bad drainage, rough potholes, dusty in summer. Ditches only deep enough for run-off on one side.	10/7/2015	10/7/2015	rough conditions.
2	Homestead Dr.	The new road behind Walgreen's needs to connect to East Redoubt. A way to identify where the sewers are so we can shovel them out in the spring time when they flood the street	10/7/2015	10/9/2015	Connectivity
3	Crest dr	Street light top of hill by Acapulco	10/8/2015	10/12/2015	Flooding
4	Acapulco	Pave it	10/8/2015	11/2/2015	Lighting
5	Reger	Another exit possibly to the Fred Meyers parking lot or something	10/10/2015	10/26/2015	rough conditions.
6	Sharkathmi Ave	Put reflective tape on the cement barrier	10/10/2015	10/10/2015	Connectivity
7	Redoubt & Binkley roundabout	Post roundabout rules. Drivers do not understand how to navigate it. They blow through it, stop and wait, do not advance or yield to vehicles on the leuyft.	10/10/2015	10/11/2015	Safety
8	Marydale	Post roundabout rules. Drivers do not understand how to navigate through it. They stop and wait, do not yield to vehicle on left, blow through it. The city can aide the smooth flow of traffic by posting the simple rules in a location where all drivers	10/10/2015	10/21/2015	Roundabout Rules
9	Binkley roundabout	Please make sure there aren't anbulbs burnt out as y winter approaches. This is a great place to run during winter, but unsafe if it's dark in spots.	10/10/2015	11/3/2015	Roundabout Rules
10	Bike Trail between Redoubt Elementary and SoHi	There are no functioning culverts here, so groundwater gets dammed and floods a lot.	10/12/2015	10/26/2015	Lighting
11	Jay/Swift/Martin	The bike/walking path here needs repair	10/13/2015	10/13/2015	Flooding
12	Spur by Birch	Would love some street lights!	10/13/2015	10/13/2015	Bike - Ped
13	Farnsworth Blvd	Would be great to connect our university system with our primary and secondary schools via a pedestrian only bridge connecting E Poppy and W Redoubt	10/14/2015	11/2/2015	Lighting
14	W Redoubt		10/26/2015	10/26/2015	Connectivity

**Comments by Category**

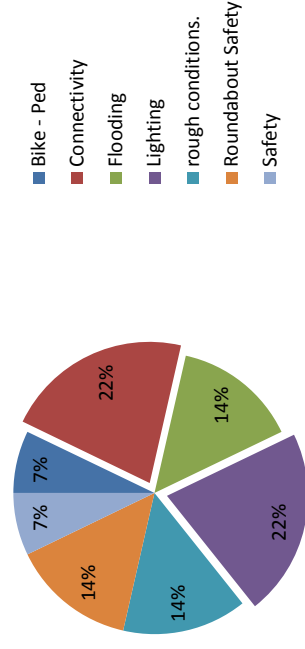

**Comments by Category**

Comment Type	1
Bike - Ped	3
Connectivity	2
Flooding	3
Lighting	2
rough conditions.	2
Roundabout Safety	1
Safety	14
Grand Total	



---

---

**APPENDIX B**

**TYPICAL SECTIONS**

---

---





<b>Client #</b>	SOLP 15-10	<b>Date</b>	December 31, 2015
<b>PDC #</b>	15050FB	<b>Prepared by</b>	Anne Nelson, PE
<b>Project Name</b>	Soldotna Streets Inventory and Management Plan	<b>Reviewed by</b>	Patrick Cotter, AICP Angela Smith, PE
<b>Subject</b>	<b>Typical Section Recommendations</b>		

Topic	Discussion
<b>Introduction</b>	As part of the Soldotna Streets Inventory and Management Plan, the consultant was asked to recommend roadway typical sections. This document evaluates Soldotna’s existing typical section standards and provides recommendations for proposed sections moving forward.

<b>Existing Standards</b>	<p>Within Soldotna city limits, the design roadway typical(s) are based on the City of Soldotna’s 1985 Standard Construction Specifications. For the areas outside the city limits, construction standards are included in the Kenai Peninsula Borough Code of Ordinances, Chapter 14.06, “Road Standards.”</p> <p>Soldotna’s existing typical section standards are limited to residential, alley ways, and collector streets.</p>
---------------------------	---

**Table 1 – Requirements from 1985 Standard Construction Specifications**

	Dimensions
<b>Right of Way</b>	60 feet wide
<b>Residential Street</b>	
<i>Minimum</i>	Two 12-foot-wide paved travel lanes Two 6-foot-wide gravel shoulders
<i>Fully Developed</i>	Two 12-foot-wide paved travel lanes Curb and gutter At least one 4-foot-wide sidewalk
<b>Collector Street</b>	
<i>Minimum</i>	Two 12-foot-wide paved travel lanes Two 6-foot-wide gravel shoulders
<i>Fully Developed</i>	Two 12-foot-wide paved travel lanes One 11-foot-wide paved center lane Two 3-foot-wide bike lanes Two 4-foot-wide sidewalks
<b>Structural Section</b>	2 inches of asphalt 2 inches of base course 6 inches of Type B classified fill 26 inches of Type A classified fill



Topic	Discussion
<b>Performance</b>	Overall, the existing structural sections are performing well. With the exception of some isolated areas, most roadway damage and deterioration identified during the PASER study is due to pavement age, not due to subgrade failure. The isolated areas of subgrade failure could be attributed to the “bury pits” left during the original construction of the roads. The original ROW clearing and road construction was performed by scraping the organic overburden to one side of the ROW, mining gravels out of the road bed, and filling the gravel excavation with the organic material prior to constructing the roadway.
<b>Factors Influencing Recommended Typical Sections</b>	Several factors, including road function and traffic volume, subgrade soils, and pedestrian/bicycle usage, contribute to development of recommended typical sections.
<b>Road Classification</b>	<p>The following functional classification system was used for the City of Soldotna. It is based on the Federal Highway Administration’s functional classification system with minor changes to accommodate the conditions in Soldotna.</p> <ul style="list-style-type: none"> <li>• <b>Major Arterial</b> – Major Arterials are usually four or more lanes and generally connect various parts of the city with one another within the city and with the “outside world.” They serve as major access routes to regional destinations and typically carry an average of more than 20,000 vehicles per day. In the Soldotna area, these are typically owned by the State of Alaska.</li> <li>• <b>Minor Arterial</b> – Minor Arterials are typically two or three lanes. These streets provide the next level of urban connectivity below major arterials. In most cases their main role tends to be serving intra-city mobility. Minor Arterials carry between 7,500 and 20,000 vehicles per day.</li> <li>• <b>Major Collector</b> – Major Collectors can be found in residential, commercial and industrial areas. They typically carry between 2,500 and 7,500 vehicles per day.</li> <li>• <b>Neighborhood Collector</b> – Neighborhood Collectors are found only in residential neighborhoods and provide a high degree of access to individual properties in a neighborhood. They typically carry between 1,500 and 2,500 vehicles per day.</li> <li>• <b>Local</b> – Local streets’ primary function is to provide access to individual property along the roadway. They are narrow, slow-speed, and low-volume service facilities. They typically carry fewer than 1,500 vehicles per day.</li> </ul>
<b>Subgrade Soil</b>	<p>Per the USDA Soil Survey, the underlying soils in the city core are primarily gravel; soils outside the city core are silty-loam and silt. Areas of peat are identified on the south side of East Redoubt. With the exception of the areas of peat, the subgrade soils are generally suitable to support roadways.</p> <p><b>Recommendation:</b> The existing structural section provided in the 1985 Standard Specifications is performing well and is recommended. This structural section is not recommended in areas underlain with deep peat layers. In those areas, a geotechnical investigation and evaluation by an Engineer is recommended to determine the appropriate</p>

---

Topic	Discussion
-------	------------

---

section for the situation.

**Shared Use**

The City has a high volume of pedestrian and bicycle traffic. Incorporating shared use into the road system is a priority.

**Recommendation:** The continued incorporation of bike lanes in Minor Arterial and Major Collector classified roads is recommended. FHWA recommends a minimum width of 4 feet for bike lanes bounded by curb and gutter.

Sidewalks are recommended on both sides of the street for Minor Arterial and Major Collectors and on one side of the road for Neighborhood Collectors. The added cost of sidewalks is not recommended for Local Roads, with their low ADT and low speeds. To meet the latest accessibility guidelines, a minimum sidewalk width of 5 feet is recommended with wider sidewalks where possible. In constrained situations, a minimum sidewalk width of 4 feet is permissible if passing areas are provided at intervals of 200 feet or less.

---

**Conclusion**









































The recommended typical sections provided are applicable to the overall conditions found in the City of Soldotna. Engineering judgment should be used when applying these typical sections to non-typical situations.

**Table 2 – Existing vs. Proposed Section Comparison**

Functional Class (Former Functional Class)	Element	Existing	Proposed
<b>Local Road</b> (Residential Minimum Development)	Lane Width	12'	12'
	Sidewalk	No	No
	Center Turn Lane	No	No
	Curb & Gutter	Standard	Rolled
<b>Neighborhood Collector</b> (Residential Full Development)	Lane Width	12'	12'
	Sidewalk	4'	5' (one side)
	Center Turn Lane	No	No
	Curb & Gutter	Standard	Standard
<b>Major Collector</b> (Collector Full Development)	Lane Width	12'	12'
	Sidewalk	4'	5'
	Bike Lane	3'	4'
	Center Turn Lane	11'	No
	Curb & Gutter	Standard	Standard
<b>Minor Arterial</b> (Collector Full Development)	Lane Width	12'	11'
	Sidewalk	4'	5'
	Bike Lane	3'	4'
	Center Turn Lane	11'	11'
	Curb & Gutter	Standard	Standard

---

## MAP LEGEND

 Area of Interest (AOI)	 Spoil Area
 Soil Map Unit Polygons	 Stony Spot
 Soil Map Unit Lines	 Very Stony Spot
 Soil Map Unit Points	 Wet Spot
 <b>Special Point Features</b>	 Other
 Blowout	 Special Line Features
 Borrow Pit	 <b>Water Features</b>
 Clay Spot	 Streams and Canals
 Closed Depression	 <b>Transportation</b>
 Gravel Pit	 Rails
 Gravelly Spot	 Interstate Highways
 Landfill	 US Routes
 Lava Flow	 Major Roads
 Marsh or swamp	 Local Roads
 Mine or Quarry	 <b>Background</b>
 Miscellaneous Water	 Aerial Photography
 Perennial Water	
 Rock Outcrop	
 Saline Spot	
 Sandy Spot	
 Severely Eroded Spot	
 Sinkhole	
 Slide or Slip	
 Sodic Spot	

## MAP INFORMATION

The soil surveys that comprise your AOI were mapped at 1:25,000. Please rely on the bar scale on each map sheet for map measurements.

Source of Map: Natural Resources Conservation Service  
Web Soil Survey URL: <http://websoilsurvey.nrcs.usda.gov>  
Coordinate System: Web Mercator (EPSG:3857)

Maps from the Web Soil Survey are based on the Web Mercator projection, which preserves direction and shape but distorts distance and area. A projection that preserves area, such as the Albers equal-area conic projection, should be used if more accurate calculations of distance or area are required.

This product is generated from the USDA-NRCS certified data as of the version date(s) listed below.

Soil Survey Area: Western Kenai Peninsula Area, Alaska  
Survey Area Data: Version 14, Sep 27, 2015

Soil map units are labeled (as space allows) for map scales 1:50,000 or larger.

Date(s) aerial images were photographed: Jan 1, 1999—Jun 22, 2012

The orthophoto or other base map on which the soil lines were compiled and digitized probably differs from the background imagery displayed on these maps. As a result, some minor shifting of map unit boundaries may be evident.



Soil Map—Western Kenai Peninsula Area, Alaska  
(City of Soldotna )

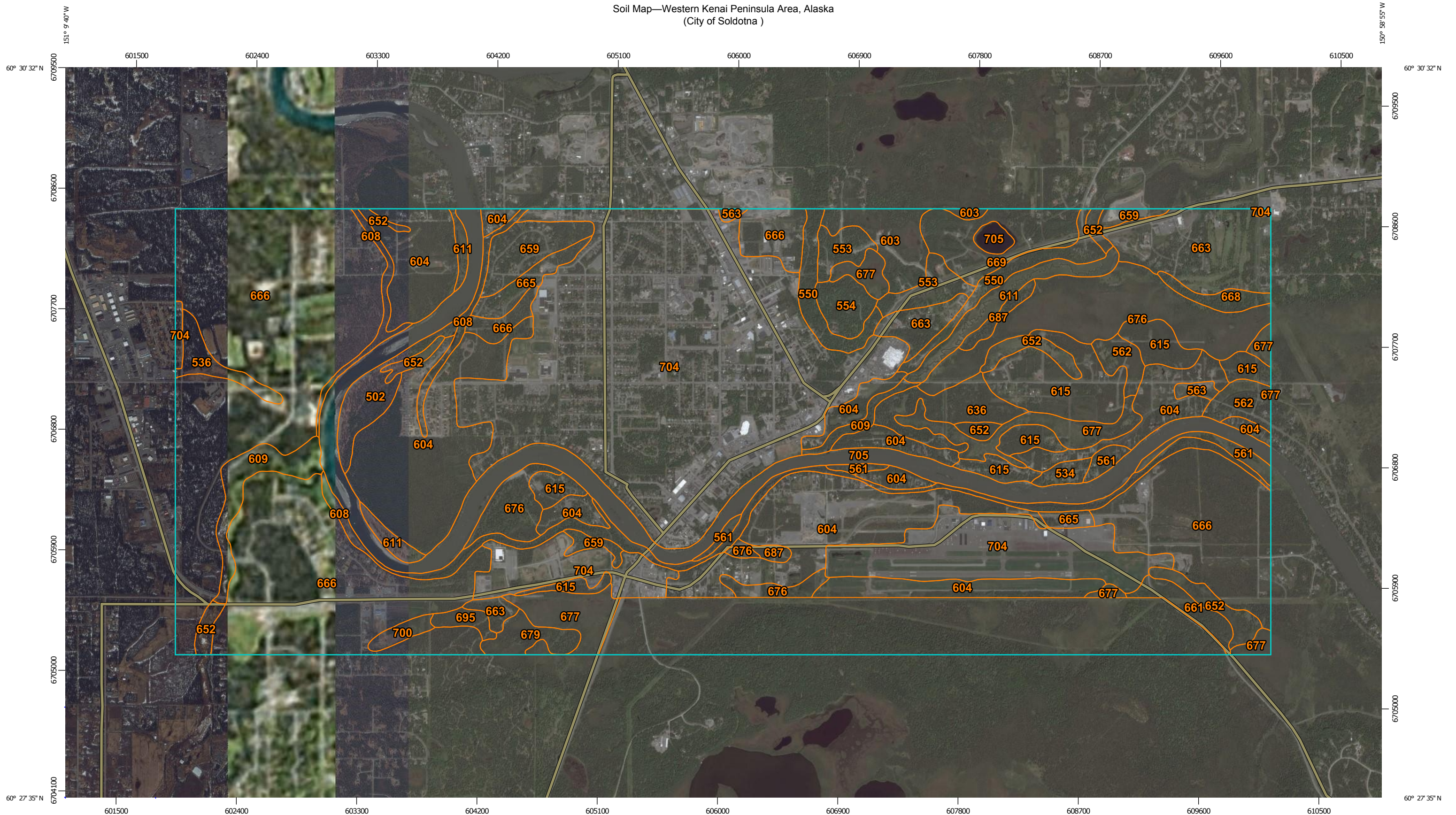

Map Scale: 1:26,500 if printed on B landscape (17" x 11") sheet.

0 350 700 1400 2100 Meters

0 1000 2000 4000 6000 Feet

Map projection: Web Mercator Corner coordinates: WGS84 Edge tics: UTM Zone 5N WGS84



*[This page intentionally left blank.]*

## Map Unit Legend

Western Kenai Peninsula Area, Alaska (AK652)			
Map Unit Symbol	Map Unit Name	Acres in AOI	Percent of AOI
502	Aquic Cryofluvents, shallow, 0 to 2 percent slopes	51.8	0.8%
534	Clam Gulch silt loam, 0 to 4 percent slopes	14.3	0.2%
536	Coal Creek silt loam, 0 to 4 percent slopes	32.3	0.5%
550	Cohoe silt loam, dry, 45 to 60 percent slopes	90.5	1.3%
553	Cohoe-Kenai complex, 8 to 15 percent slopes	62.1	0.9%
554	Cohoe-Kenai complex, 15 to 25 percent slopes	36.6	0.5%
561	Foreland peat loam, 0 to 4 percent slopes	42.8	0.6%
562	Foreland-Starichkof-Soldotna complex, undulating	55.5	0.8%
563	Gravel pits	12.0	0.2%
603	Kenai-Starichkof association, 0 to 25 percent slopes	71.3	1.1%
604	Kichatna silt loam, 0 to 8 percent slopes	859.7	12.7%
608	Kichatna silt loam, 45 to 60 percent slopes	152.8	2.3%
609	Kichatna-Killey association, 0 to 65 percent slopes	75.1	1.1%
611	Killey and Moose River soils, 0 to 2 percent slopes	80.3	1.2%
615	Longmare silt loam, 0 to 4 percent slopes	228.6	3.4%
636	Nikolai peat, 0 to 4 percent slopes	70.8	1.0%
652	Slikok peat, 0 to 4 percent slopes	92.7	1.4%
659	Soldotna silt loam, 0 to 4 percent slopes	81.3	1.2%
661	Soldotna silt loam, 8 to 15 percent slopes	30.1	0.4%
663	Soldotna silt loam, sandy substratum, 4 to 8 percent slopes	200.6	3.0%
665	Soldotna silt loam, sandy substratum, 15 to 25 percent slopes	42.7	0.6%

Western Kenai Peninsula Area, Alaska (AK652)			
Map Unit Symbol	Map Unit Name	Acres in AOI	Percent of AOI
666	Soldotna silt loam, sandy substratum, undulating	1,416.4	20.9%
668	Soldotna, sandy substratum-Kenai complex, 25 to 45 percent slopes	22.4	0.3%
669	Soldotna, sandy substratum-Kenai complex, undulating	94.7	1.4%
676	Starichkof and Doroshin soils, 0 to 4 percent slopes	282.9	4.2%
677	Starichkof peat, 0 to 4 percent slopes	165.7	2.4%
679	Starichkof peat, forested, 0 to 6 percent slopes	33.6	0.5%
687	Tangerra silt loam, 0 to 6 percent slopes	21.4	0.3%
695	Truuli muck, 0 to 4 percent slopes	15.0	0.2%
700	Tuxedni silt loam, warm, 0 to 8 percent slopes	14.8	0.2%
704	Urban land	1,486.7	22.0%
705	Water, fresh	362.1	5.4%
<b>Subtotals for Soil Survey Area</b>		<b>6,299.7</b>	<b>93.1%</b>
<b>Totals for Area of Interest</b>		<b>6,765.2</b>	<b>100.0%</b>



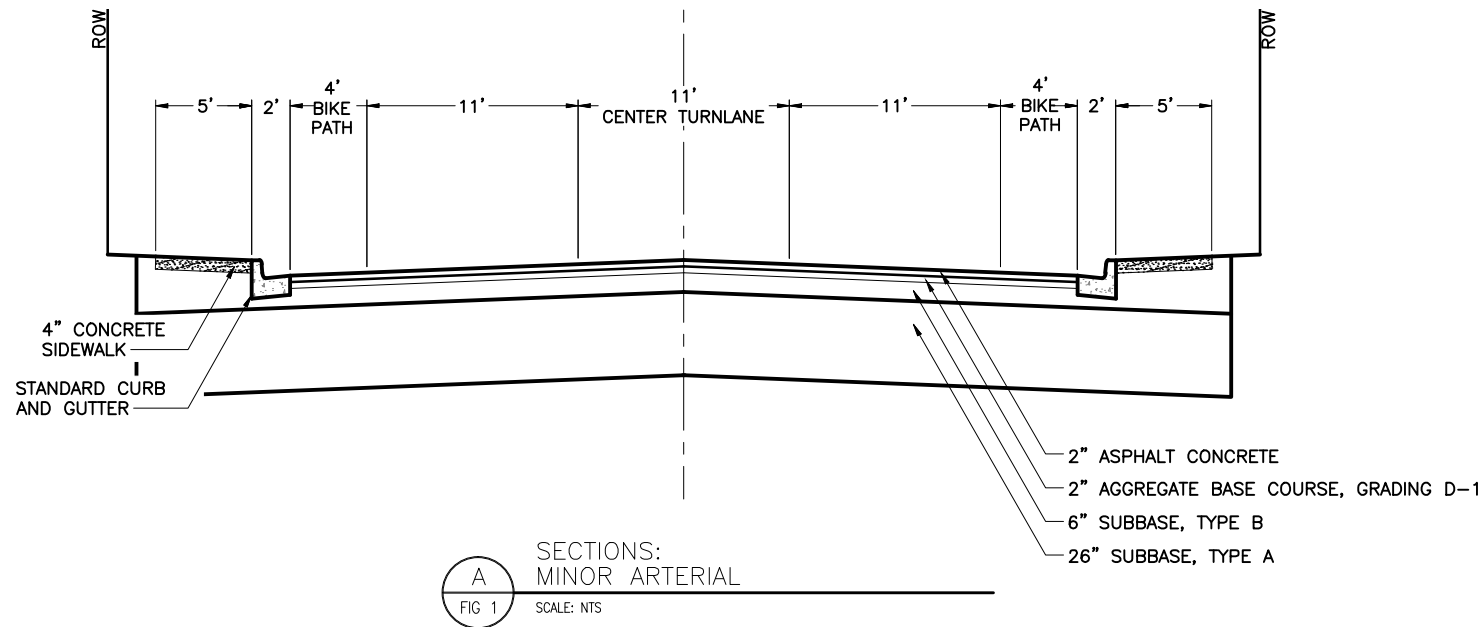

SECTION: A  
MINOR ARTERIAL  
FIG 1 SCALE: NTS

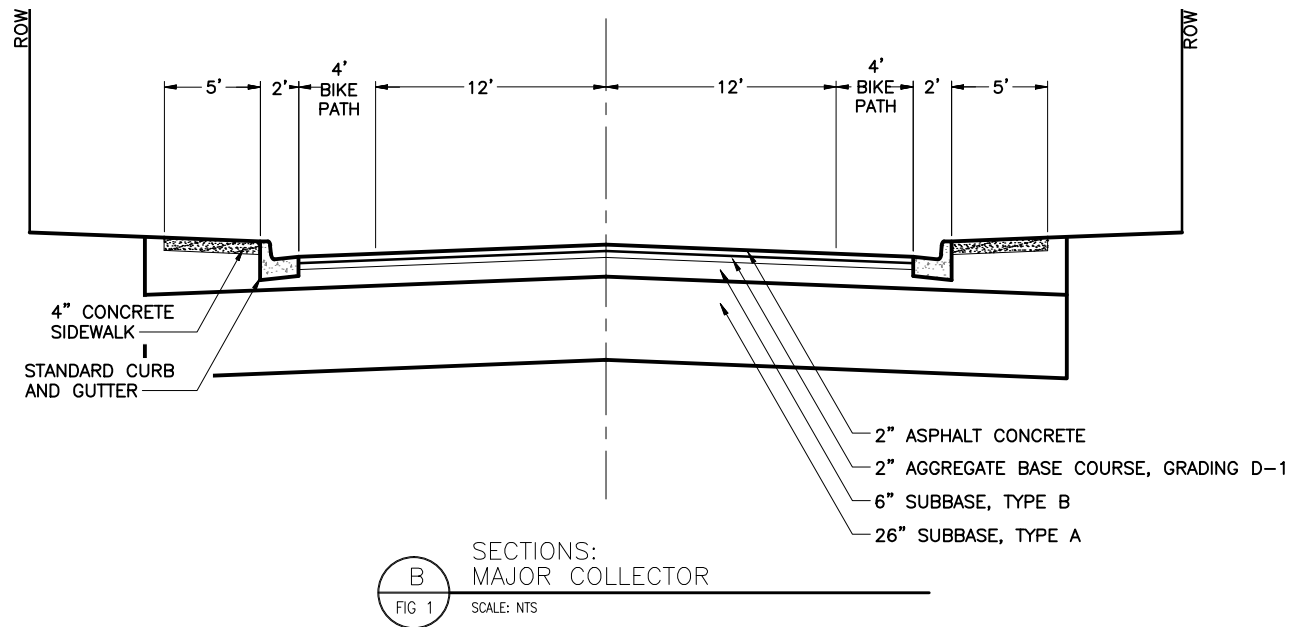

SECTION: B  
MAJOR COLLECTOR  
FIG 1 SCALE: NTS

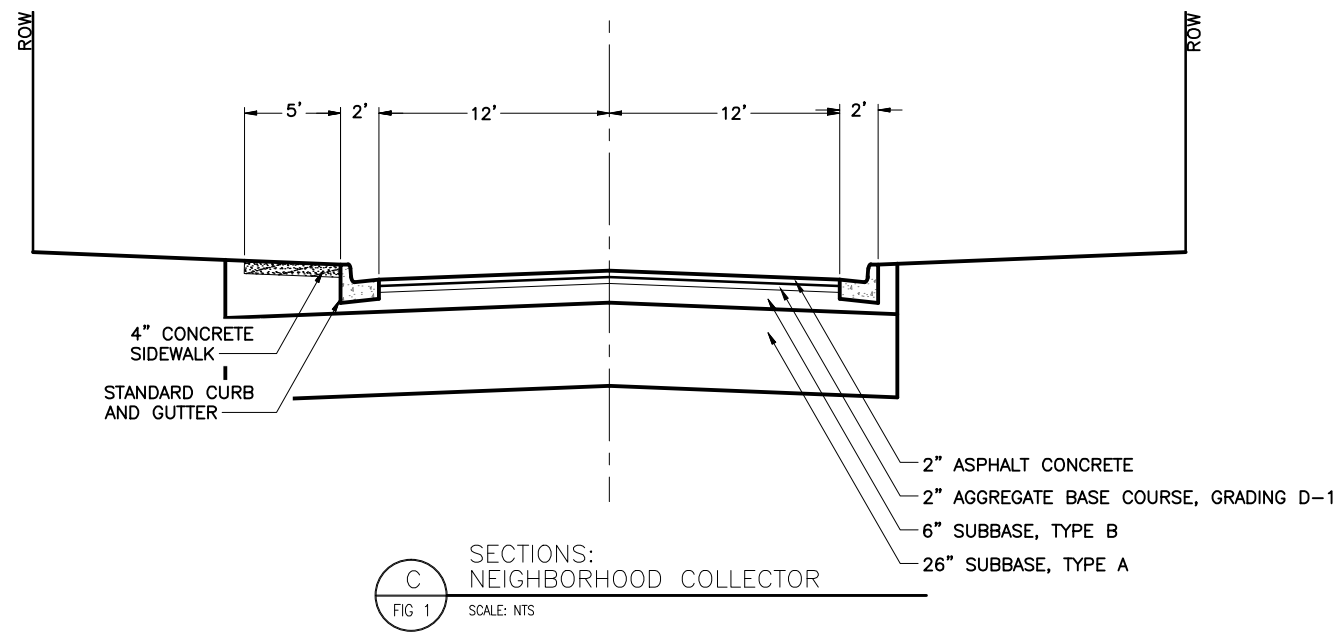

SECTION: C  
NEIGHBORHOOD COLLECTOR  
FIG 1 SCALE: NTS

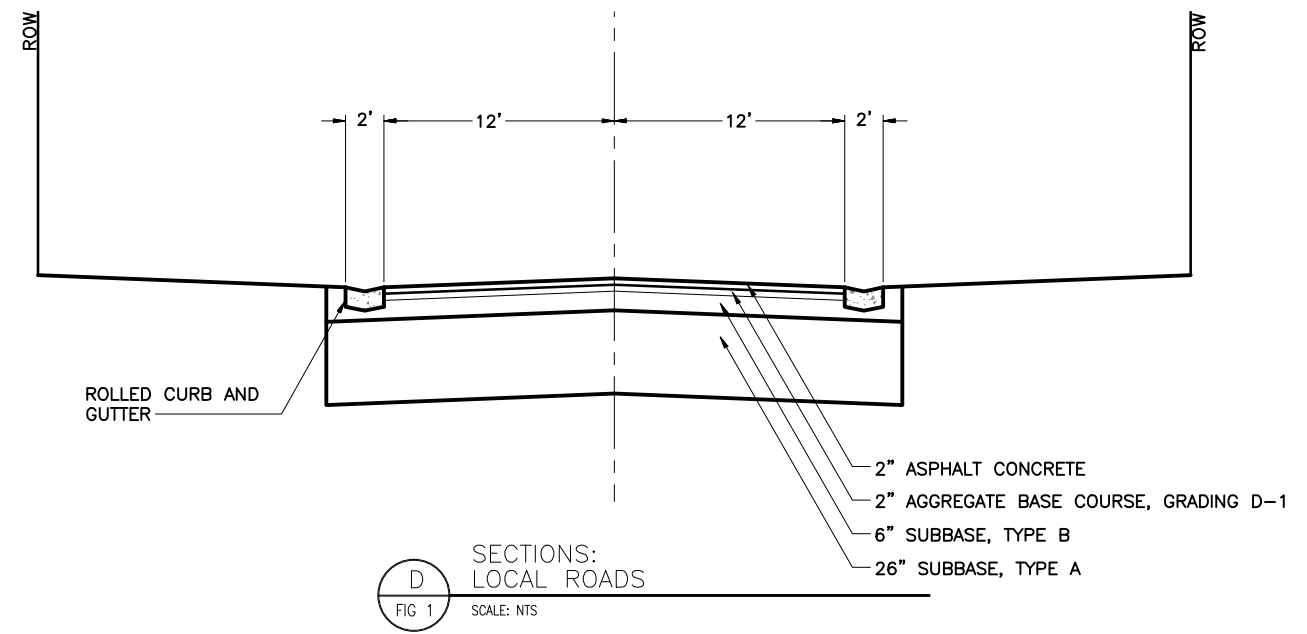

SECTION: D  
LOCAL ROADS  
FIG 1 SCALE: NTS

CONSULTANT :



PROJECT :  
SOLDOTNA STREETS INVENTORY  
AND MANAGEMENT PLAN

SHEET TITLE :  
TYPICAL ROAD  
SECTIONS - URBAN

DESIGN	
DRAWN	
CHECKED	
DATE	NOV 2015
PROJECT No.	15050FB
SHEET NUMBER	FIG 1
OF	SHEETS

*[This page intentionally left blank.]*

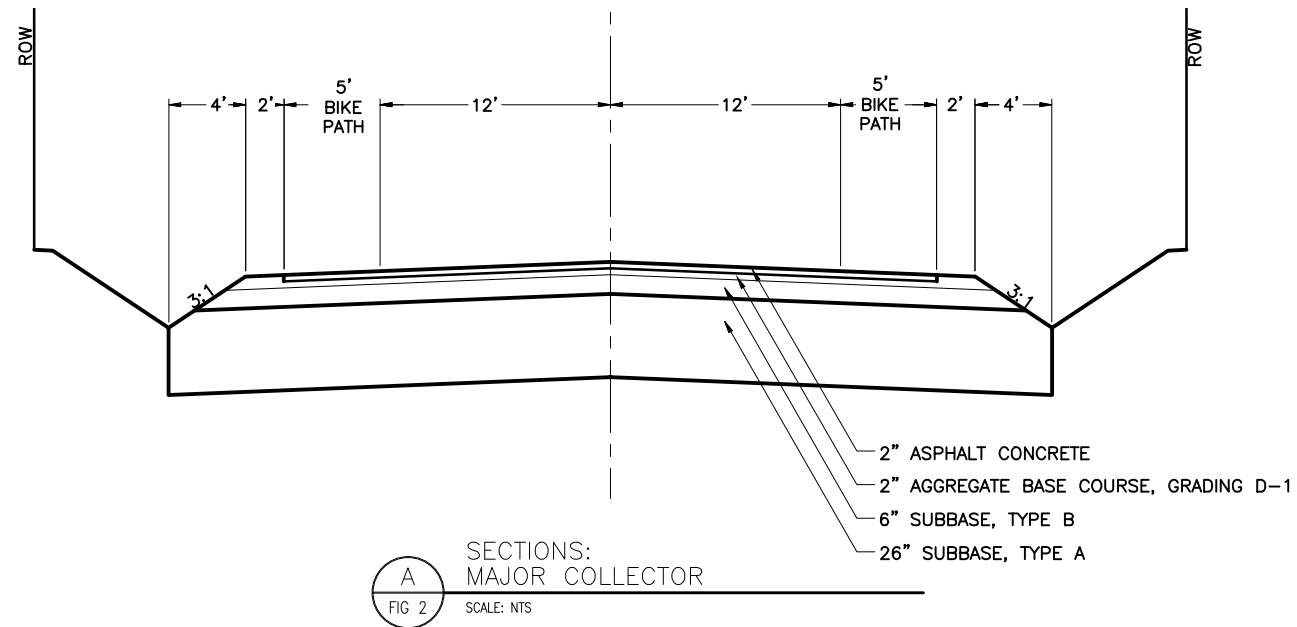

SECTION: MAJOR COLLECTOR  
 A  
 FIG 2 SCALE: NTS

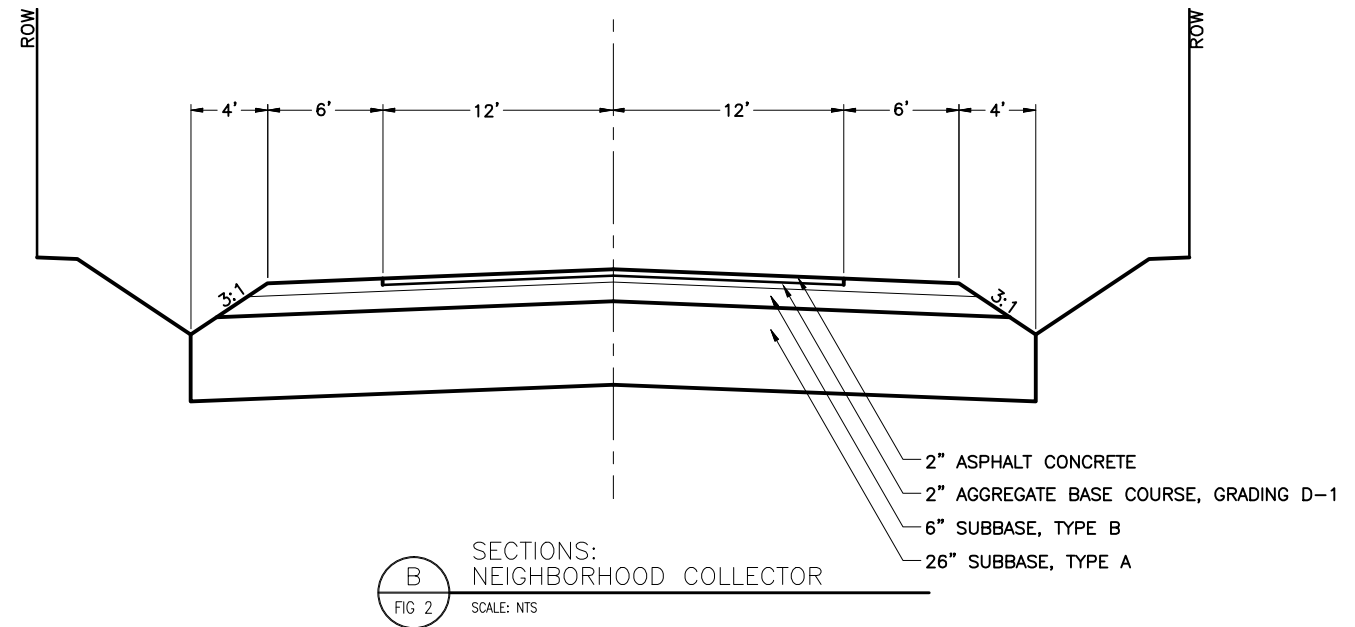

SECTION: NEIGHBORHOOD COLLECTOR  
 B  
 FIG 2 SCALE: NTS

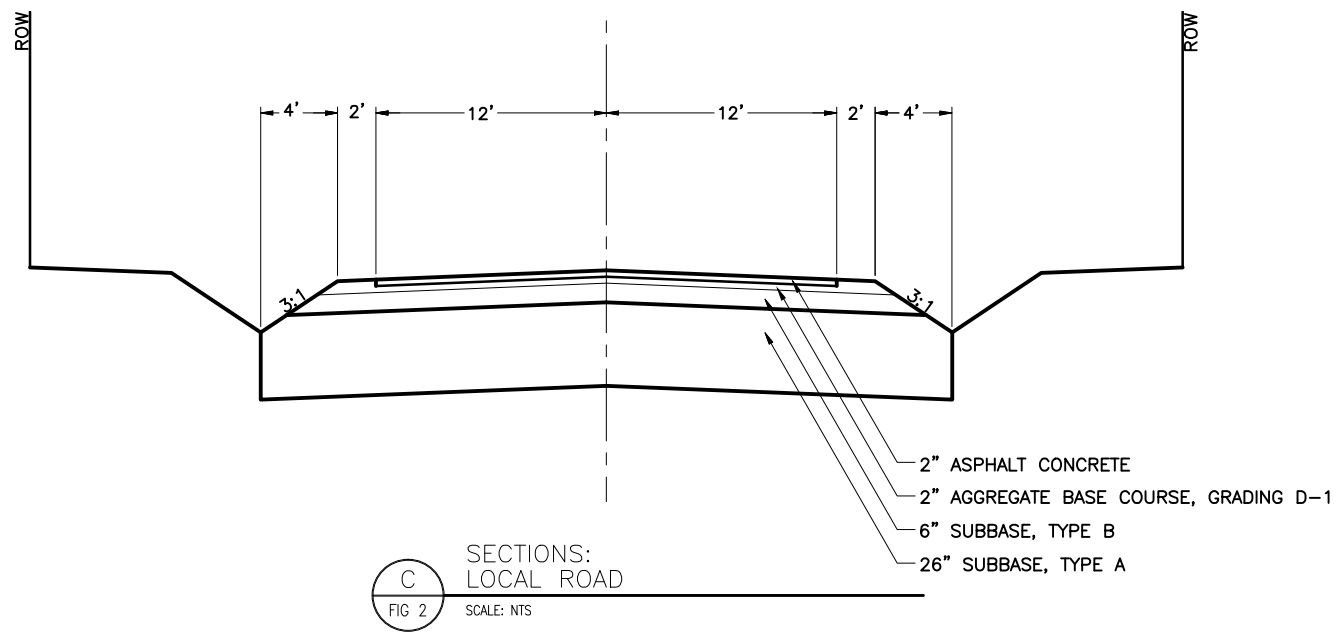

SECTION: LOCAL ROAD  
 C  
 FIG 2 SCALE: NTS

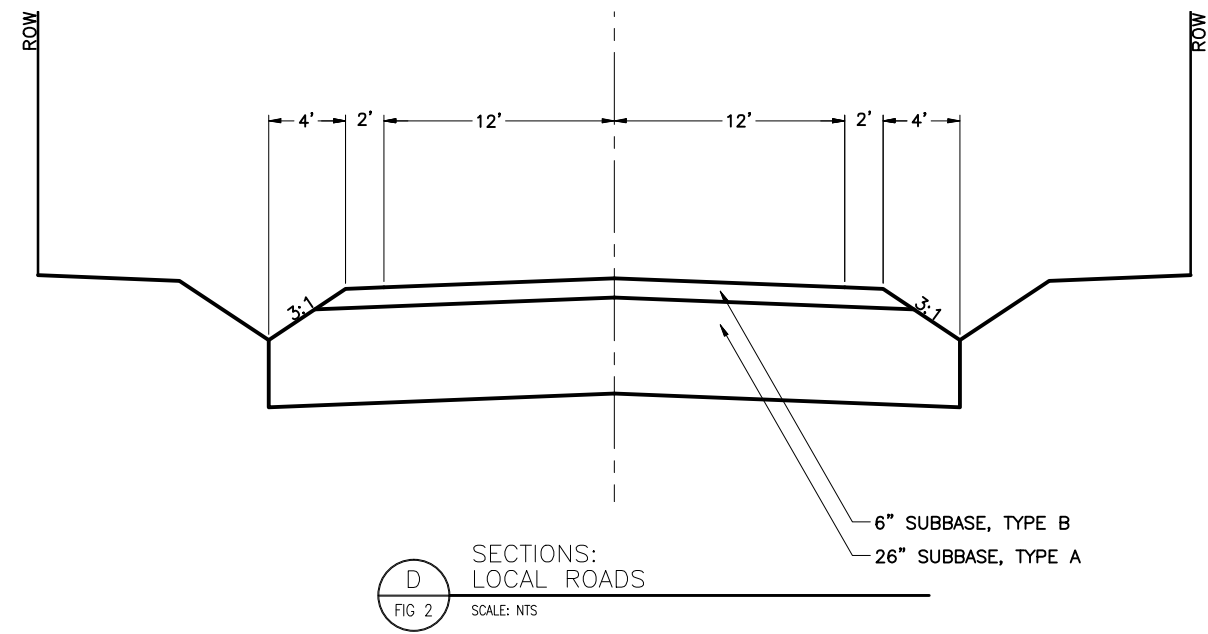

SECTION: LOCAL ROADS  
 D  
 FIG 2 SCALE: NTS

CONSULTANT :



PROJECT : SOLDOTNA STREETS INVENTORY AND MANAGEMENT PLAN

SHEET TITLE : TYPICAL ROAD SECTIONS - RURAL

DESIGN	
DRAWN	
CHECKED	
DATE	DEC 2015
PROJECT No.	15050FB
SHEET NUMBER	FIG 2
OF SHEETS	

*[This page intentionally left blank.]*

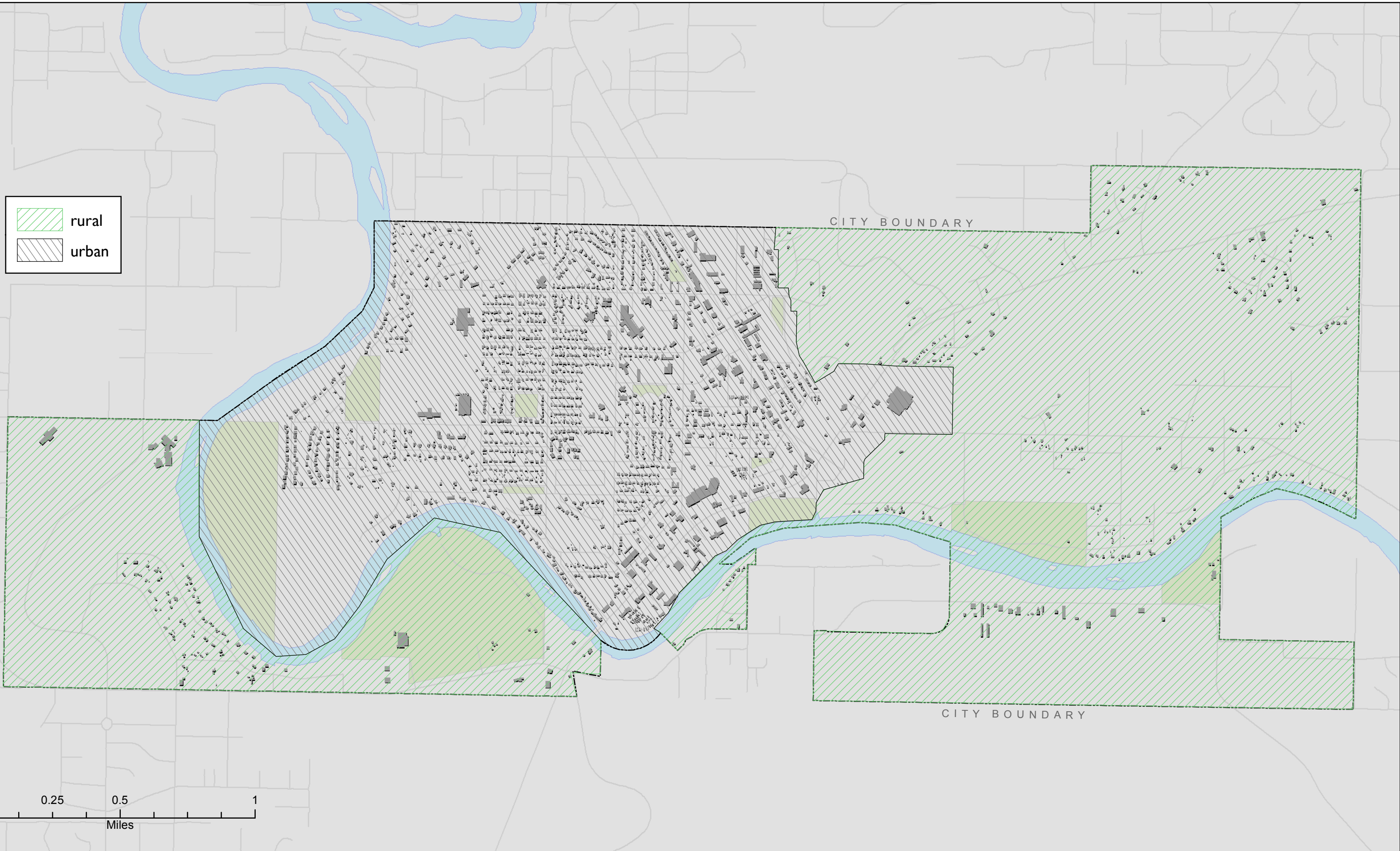
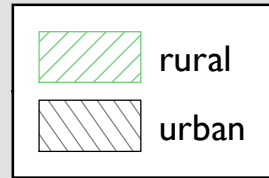

*[This page intentionally left blank.]*

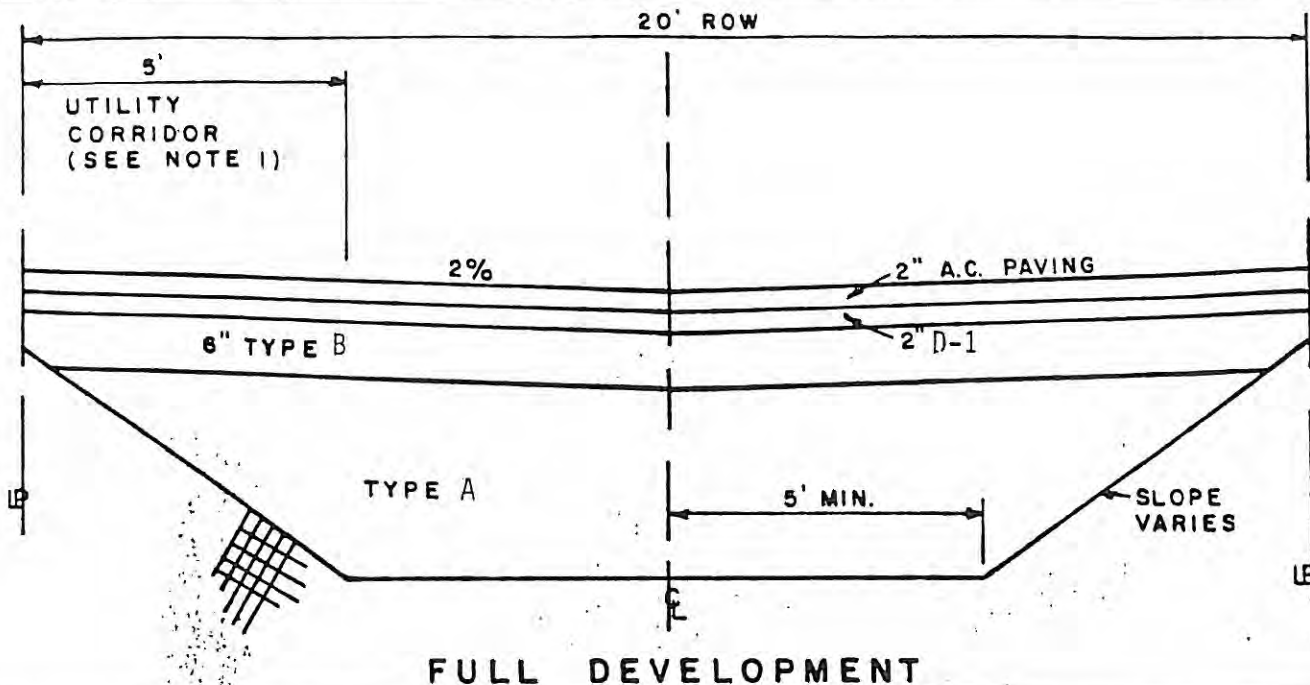

**FULL DEVELOPMENT**

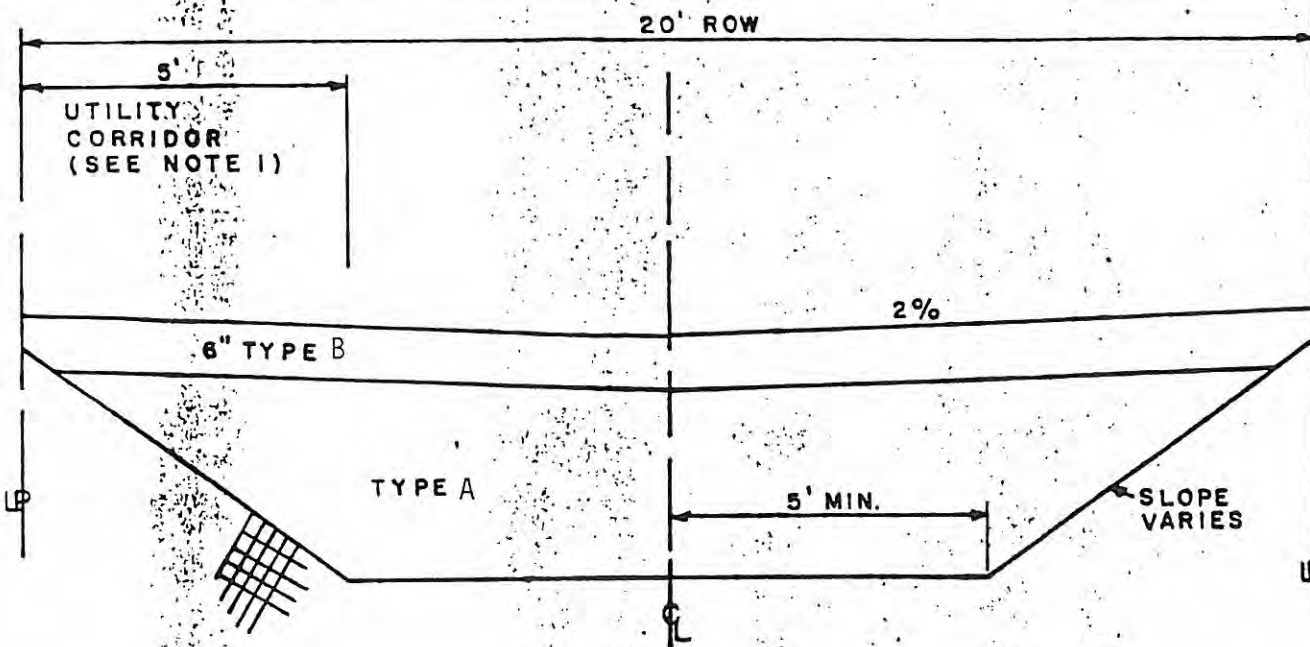

**MINIMUM DEVELOPMENT**

- NOTES: 1. UTILITY CORRIDORS WILL BE LOCATED ON THE WEST OR SOUTH SIDE.  
 2. TOP 6" LAYER OF TYPE B SHALL BE 3" MINUS CLASSIFIED FILL OR BACKFILL  
 3. TYPE A SHALL CONSIST OF CLASSIFIED FILL UNLESS OTHERWISE APPROVED.  
 4. ALL ORGANIC MATERIAL BELOW THE SUBGRADE SHALL BE REMOVED UNLESS OTHERWISE APPROVED BY THE ENGINEER.  
 5. MINIMUM DEPTH OF SECTION— 36 INCHES UNLESS OTHERWISE APPROVED BY THE CITY ENGINEER.  
 6. TYPE A OR B MATERIAL SHALL NOT HAVE MORE THAN 6% MINUS 200 MATERIAL AS DETERMINED BY ALASKA TEST METHOD T-7.

		CITY OF SOLDOTNA	SCALE: H=1"=3' V=1"=2'
	"D"	ALLEY	DATE: 11/85
			DETAIL 70-13

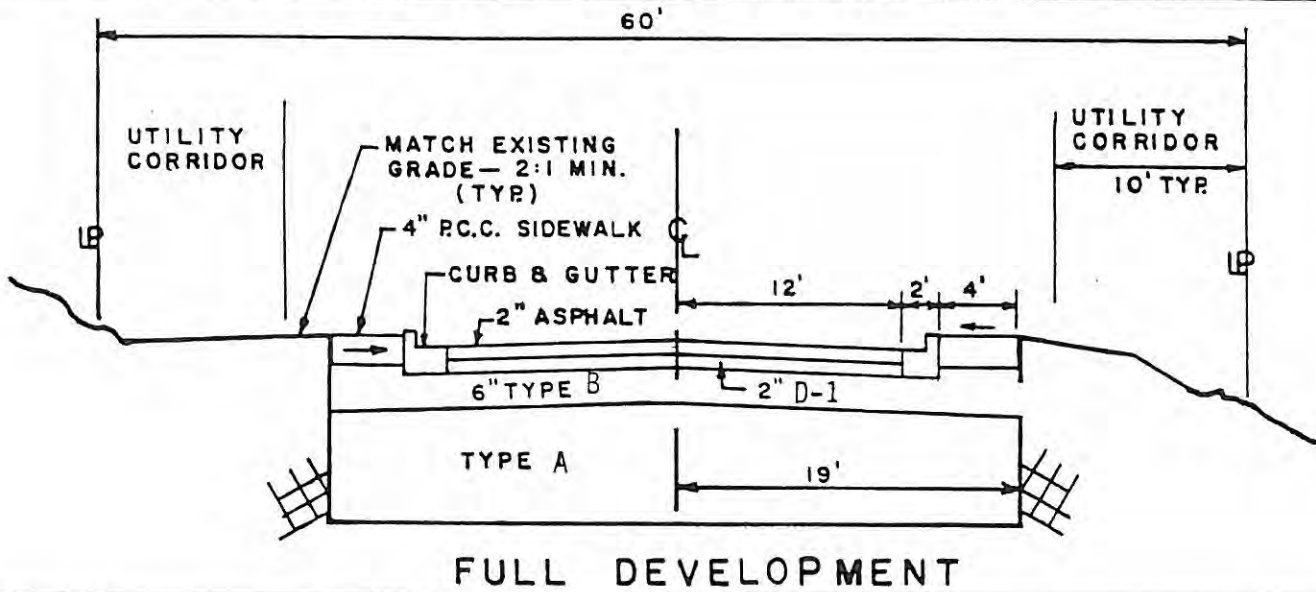
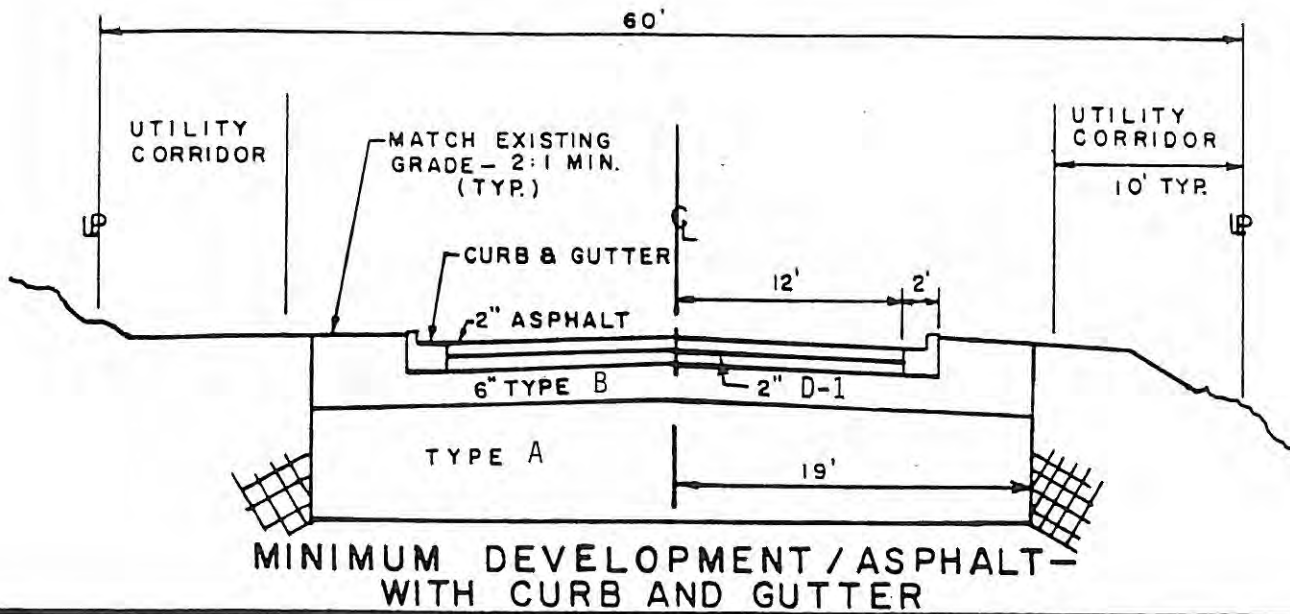

- NOTES:
1. TYPE B SHALL CONSIST OF 3" MINUS MATERIAL AND SHALL BE CLASSIFIED FILL OR BACKFILL.
  2. TYPE A SHALL CONSIST OF CLASSIFIED FILL UNLESS OTHERWISE APPROVED.
  3. TYPE A OR B SHALL BE COMPACTED TO NOT LESS THAN 95% COMPACTION.
  4. ALL ORGANIC MATERIAL BELOW THE SUBGRADE SHALL BE REMOVED UNLESS OTHERWISE APPROVED BY THE CITY ENGINEER.
  5. MINIMUM DEPTH OF SECTION—36 INCHES UNLESS OTHERWISE APPROVED BY THE CITY ENGINEER.
  6. TYPE A OR B MATERIAL SHALL NOT HAVE MORE THAN 6% MINUS 200 MATERIAL AS DETERMINED BY ALASKA TEST METHOD T-7.

		CITY OF SOLDOTNA	SCALE: 1" = 10'
	"C-1"	RESIDENTIAL STREET	DATE: 12 / 85
			DETAIL: 70-12



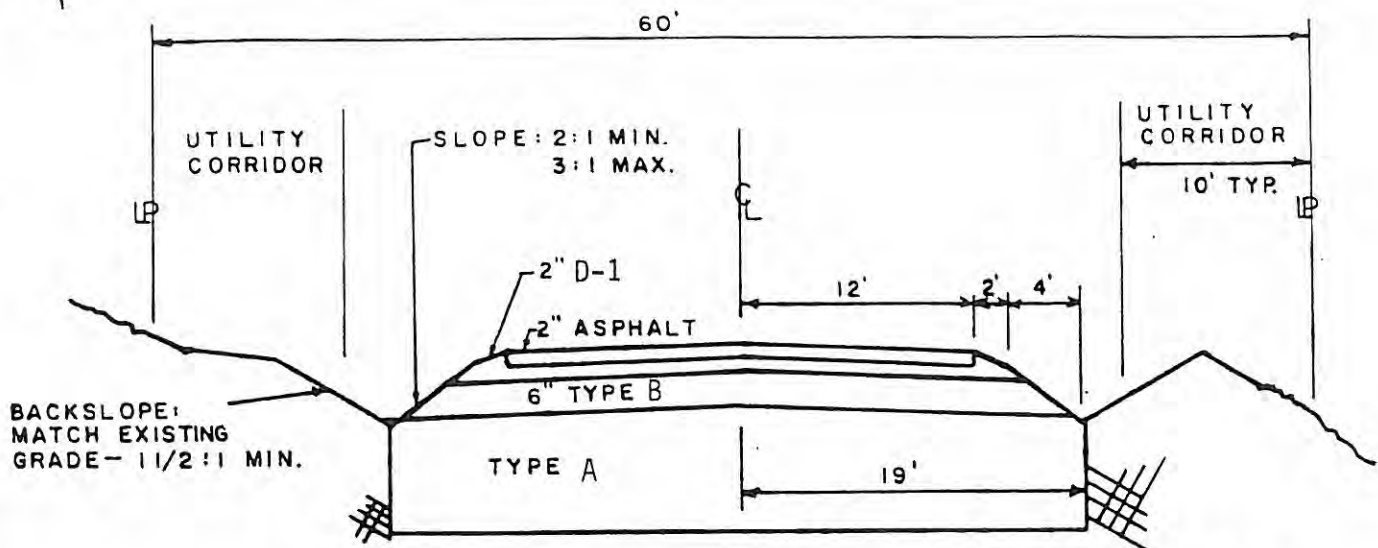

### MINIMUM DEVELOPMENT/ASPHALT

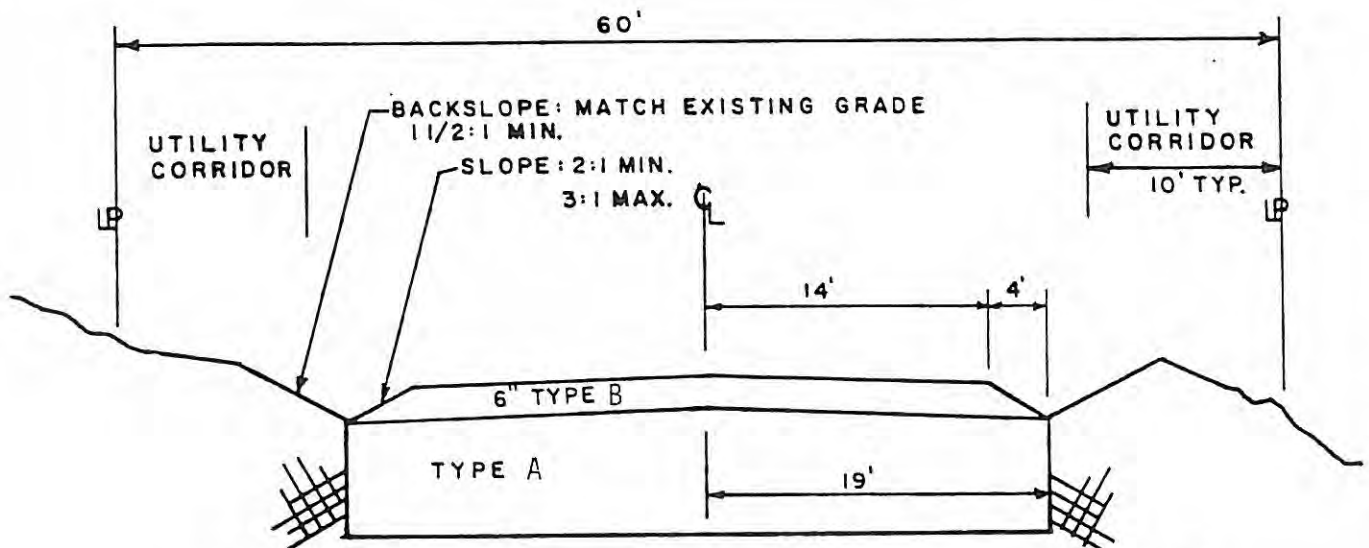

### MINIMUM DEVELOPMENT/GRAVEL

- NOTES:
1. TYPE B SHALL CONSIST OF 3" MINUS MATERIAL AND SHALL BE CLASSIFIED FILL OR BACKFILL.
  2. TYPE A SHALL CONSIST OF CLASSIFIED FILL UNLESS OTHERWISE APPROVED.
  3. TYPE A OR B SHALL BE COMPACTED TO NOT LESS THAN 95% COMPACTION.
  4. ALL ORGANIC MATERIAL BELOW THE SUBGRADE SHALL BE REMOVED UNLESS OTHERWISE APPROVED BY THE CITY ENGINEER.
  5. MINIMUM DEPTH OF SECTION— 36 INCHES UNLESS OTHERWISE APPROVED BY THE CITY ENGINEER. DITCH SECTION— 2' SWALE SECTION— 6"
  6. TYPE A OR B MATERIAL SHALL NOT HAVE MORE THAN 6% MINUS 200 MATERIAL BY ALASKA TEST METHOD T-7.

"C"	CITY OF SOLDOTNA	SCALE: 1"=10'
	RESIDENTIAL STREET	DATE: 12/85
		DETAIL: 70-11

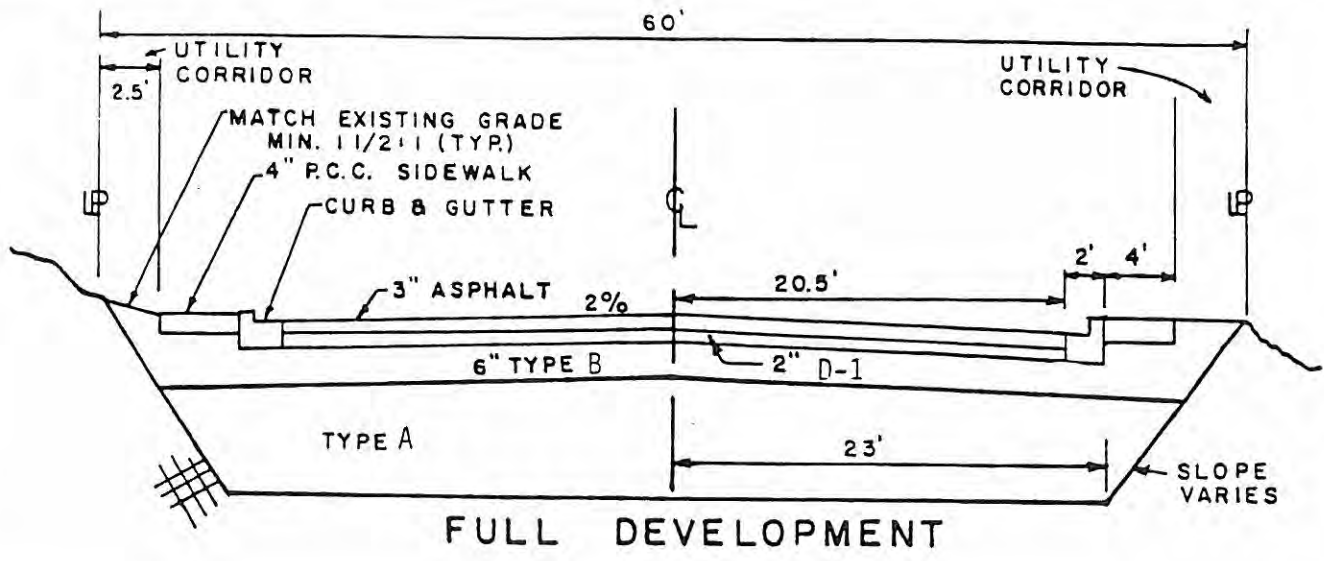

FULL DEVELOPMENT

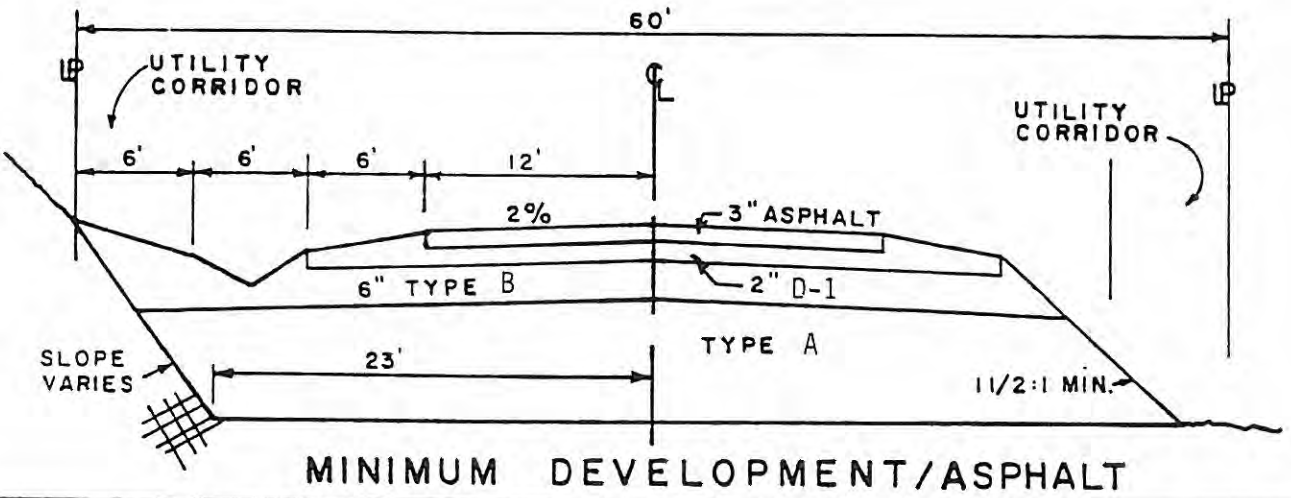

MINIMUM DEVELOPMENT/ASPHALT

- NOTES:
1. DITCH SECTION—2' SWALE SECTION—6" MAX.
  2. TOP 6" LAYER OF TYPE B SHALL BE 3" MINUS CLASSIFIED FILL OR BACKFILL.
  3. TYPE A SHALL CONSIST OF CLASSIFIED FILL UNLESS OTHERWISE APPROVED.
  4. ALL ORGANIC MATERIAL BELOW THE SUBGRADE SHALL BE REMOVED UNLESS OTHERWISE APPROVED BY THE ENGINEER.
  5. MINIMUM DEPTH OF SECTION—36 INCHES UNLESS OTHERWISE APPROVED BY THE CITY ENGINEER.
  6. TYPE A&B SHALL BE COMPACTED TO NOT LESS THAN 95% COMPACTION.
  7. TYPE A OR B MATERIAL SHALL NOT HAVE MORE THAN 6% MINUS 200 MATERIAL AS DETERMINED BY ALASKA TEST METHOD T-7.

	"B"	CITY OF SOLDOTNA	SCALE: 1"=10'
		COLLECTOR STREETS	DATE: 11/85
			DETAIL: 70-10